

DA200

High Performance AC Servo System



Contents

| | |
|---|----|
| Introduction..... | 2 |
| Servo product family..... | 3 |
| Outstanding product performance..... | 4 |
| Abundant practical functions..... | 5 |
| Intelligence..... | 7 |
| User-friendly operation software..... | 9 |
| Application cases..... | 11 |
| Servo drive models..... | 14 |
| Servo drive technical parameters..... | 17 |
| Servo system configuration table..... | 19 |
| Servo motor models..... | 20 |
| Servo motor technical parameters..... | 21 |
| Servo motor installation dimensions..... | 22 |
| Servo motor torque-speed characteristics..... | 25 |
| Servo motor power cable models..... | 27 |
| Servo motor power cable wiring..... | 28 |
| Servo motor encoder cable models..... | 29 |
| Servo motor encoder cable wiring..... | 30 |
| Connection ports..... | 31 |
| System wiring..... | 35 |
| Standard wiring diagram..... | 36 |
| Ordering guide for servo system..... | 40 |
| Other INVT industrial control products..... | 41 |
| One-stop service & marketing network..... | 42 |

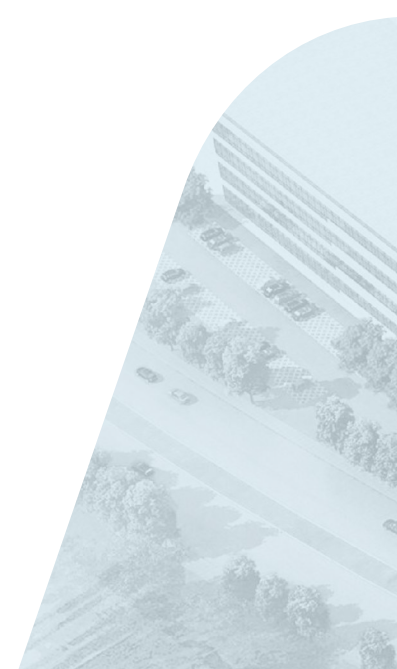



/ Introduction

DA200 series high performance AC servo system is an INVT flagship product that is developed according to market needs and aims at assisting customers in industry. Applying the leading control performance to actual industrial needs achieves a perfect combination of the servo system and application environment.

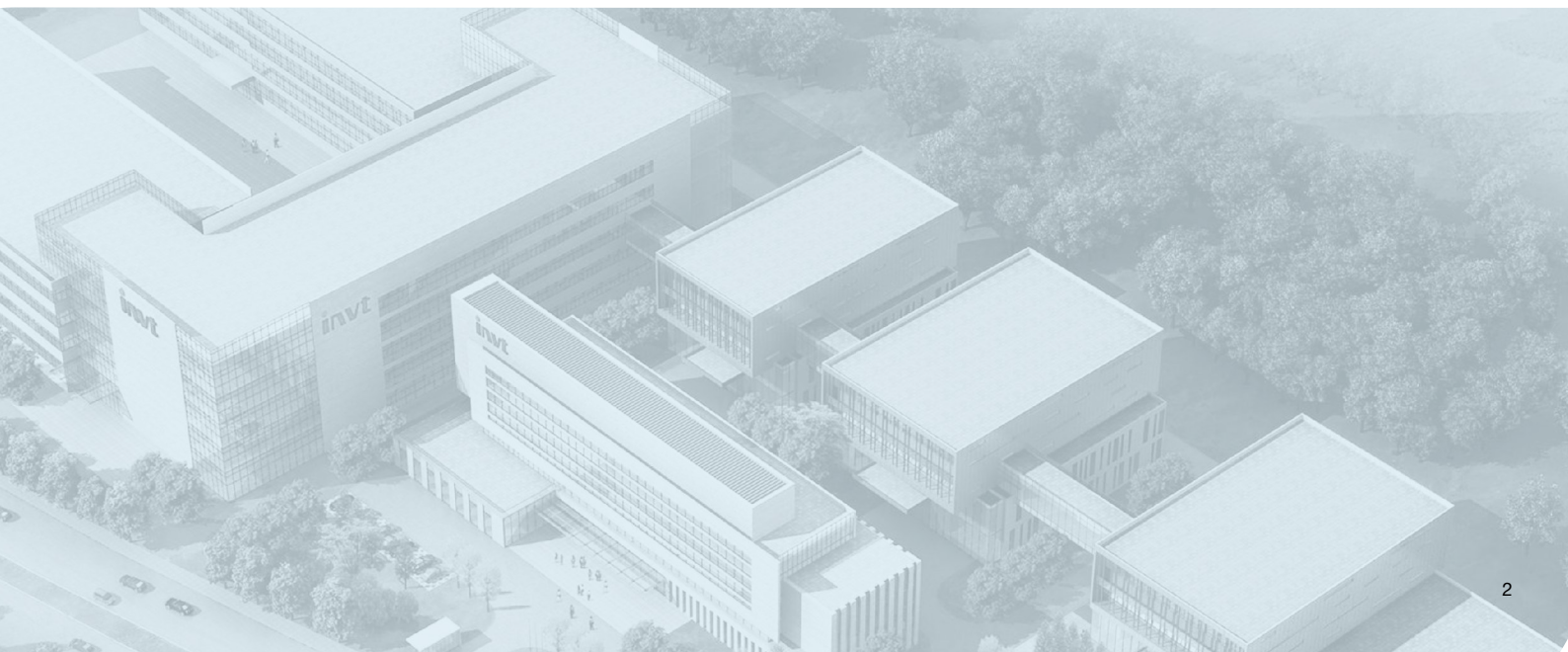

Servo product family

Comprehensive product series support various networks and matching devices, facilitating the construction of required systems.

Drive layer



DA180 basic AC servo system



DA200 high performance AC servo system



DA300 intelligent AC servo system



DA212 dual-axis AC servo system



MH860A electrohydraulic servo system



DL310 DC Low voltage servo drive

Execution layer



Small power servo motor



Medium power servo motor



Synchronous motor

Outstanding product performance

Industry-leading speed response

The speed response frequency can reach 2.0kHz, improving the processing rate and reducing the tuning time, with the full use of advanced mechanical performance.

3times
of a common
product
2kHz

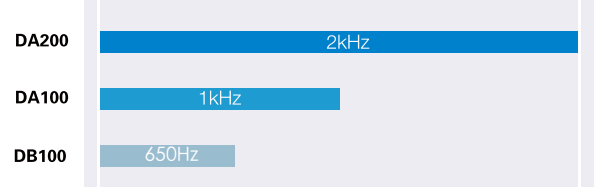

Accurate positioning

The support for the 23-bit encoder with the 0.15 arcsecond resolution achieves accurate positioning, stable machining at low speed, and bright and clean machined surface. The use of an absolute encoder ensures the motor will not lose the position origin in case of power-off.

64times
of a common
product
23bit

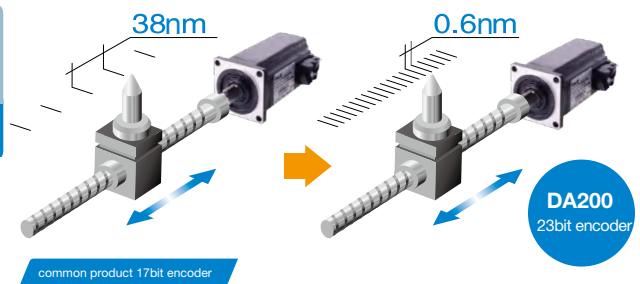

Applicable to scenarios that require absolute positions with high rigidity, such as robot, LED optical splitter, high speed drilling center, warp knitting machine, engraving and milling machine, turning and milling combined machine, and tool servo.

Enriched communication interfaces

Networking based on Modbus, CANopen, PROFINET, or EtherCAT achieves remote, multi-shaft, high-speed, synchronous control.



Abundant practical function

Fully-closed loop control

Support for external connection to an encoder or grating ruler installed at the load end, implementing fully-closed loop control, reducing back clearance impact caused by mechanical drive, and improving machine-end positioning accuracy.

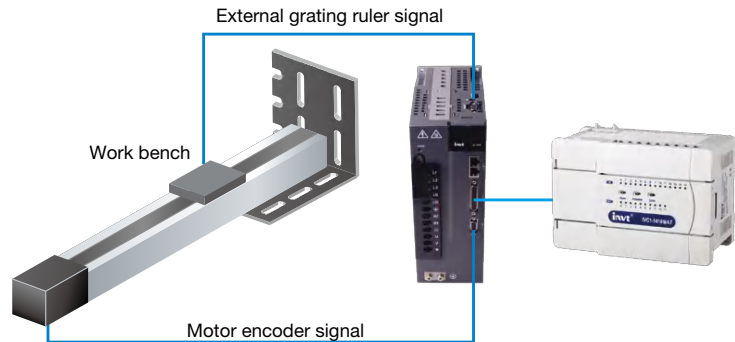

Internal position control

Achieving 128-segment internal position control with combination of input terminal commands (external I/O or bus control). For simple motion control, the internal program design can help simplify the PLC and optimize the external configuration plan.

| PtP0.00 | Control word of segment 00 | Setting range | Default | Unit | Control mode |
|---------|----------------------------|---------------|---------|------|--------------|
| | | 0~0x7FFFFFFF | 0 | - | P |

Overall description

| Data bit | Name | Function |
|----------|------|----------------------------|
| Bit0~3 | MODE | PTP running mode. |
| Bit4~7 | OPT | Segment attribute. |
| Bit8~11 | ACC | ACC/DEC time index. |
| Bit12~15 | SPD | Target speed index. |
| Bit16~19 | DLY | Delay time index. |
| Bit20~23 | CYL | Segment execution cycles. |
| Bit24~30 | JMP | Jumps to the next segment. |

Description for MODE

| MODE | Meaning |
|------|--|
| 0 | Stops after executing the current segment. |
| 1 | Jumps to the next segment after executing the current segment. |
| 2 | Stops after circular execution. If CMD is 1, circulation is invalid. |
| 3 | Jumps to the next segment after circular execution. If CMD is 1, circulation is invalid. |

Description for OPT

| Data bit | Name | Function |
|----------|------|--|
| Bit4 | INS | Insertion. The current segment has the execution termination privilege over segments that are being executed or not executed |
| Bit5 | OVL | Overlap. The current and next segments can be overlapped for execution. |
| Bit6~7 | CMD | Position command type. 0: incremental position; 1: absolute |

Electronic cam

- The cam profile can consist of 3600 points.
- Automatic smooth interpolation can be implemented between two points of a curve, making mechanical motions more smooth.
- The ServoPlover software supports cam planning and setting.
- Applicable to master/slave application scenarios such as flying and rotary shears.

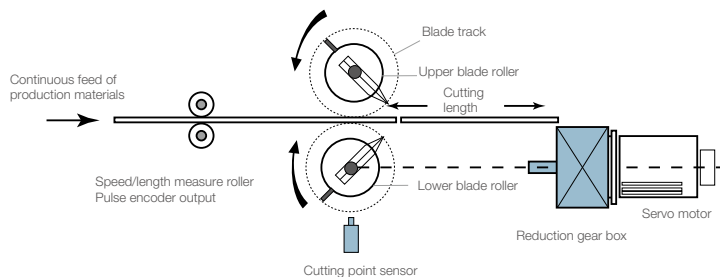

Linear motor control

Support for control on linear motors, including those without magnetic sensors. After magnetic pole detection is enabled, the motor executes minor FWD-and-RVS motions for detection. After the detection is completed, the servo is ready for motion control.

Function description

To work with 3rd-party linear motors, position sensor signals should be 5V differential ABZ signals. The maximum allowed pulse signal frequency of the drive is single-channel 3MHz or orthogonal 12MHz. Magnetic sensor signals (optional) support differential input.

Features

If a linear motor without magnetic sensors is used, it executes first power-on or using magnetic pole detection signals. The minor FWD-and-REV motions for the pole detection after the rotor moving range is within 2mm (configurable). The internal stalling protection function ensures linear motor safety. The ASR bandwidth can reach 1kHz or higher, and the position tuning time is less than 5ms.

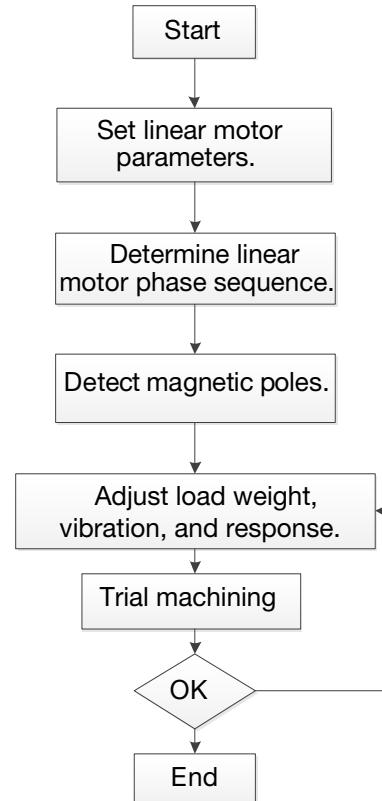

Load inertia identifying

Providing online and offline inertia identifying. Automatically identifying gain parameters in the system reduces system tuning time.

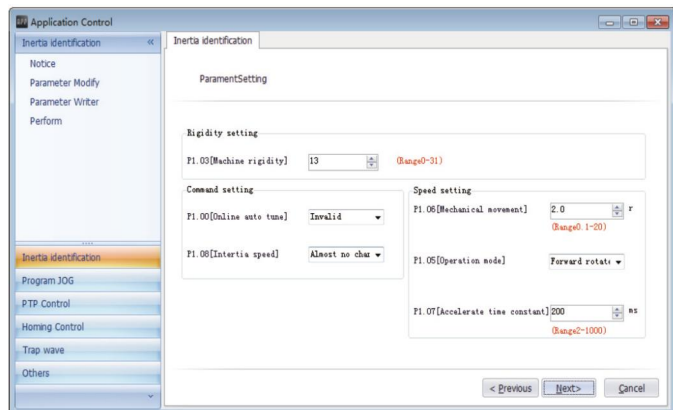

Intelligence

Automatic/manual notch filter

Simplified notch filter setup achieves automatic vibration detection without vibration frequency. Abnormal noise and vibration caused by mechanical devices can be greatly reduced by using a notch filter.

DA200 series product carries four notch filters, each of which has frequency designated to 50Hz – 5000Hz and adjustable depth. (Two of the filters can be automatically set.)

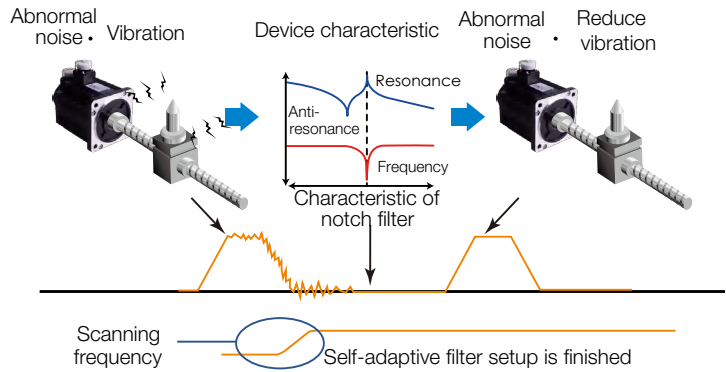

Low frequency vibration control

Special low frequency vibration control algorithms can be used to effectively control low frequency mechanical resonance and control oscillation at long swing arm end.

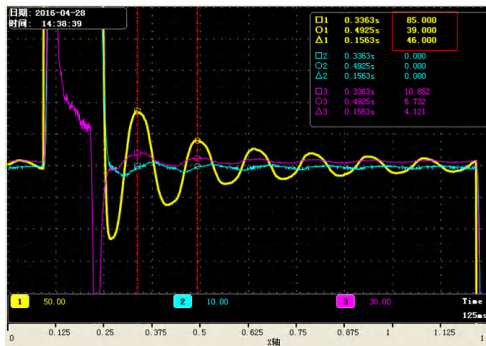

Vibration control is not conducted

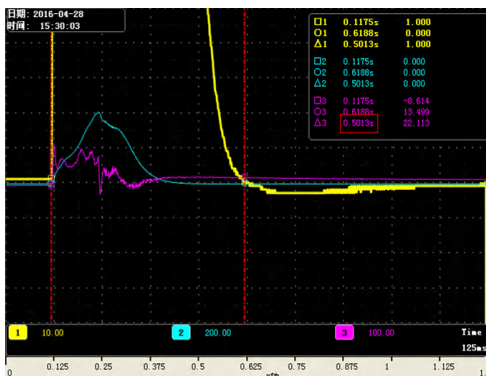

Vibration control is conducted

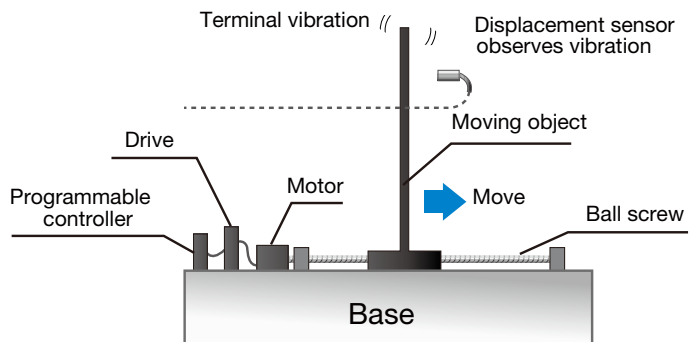

■ Gantry synchronism

Support for dual-shaft alignment and synchronous following. The controller conducts synchronous control automatically without the complicated upper PC control. When position deviation exceeds the allowed value, an alarm is reported to stop system running.

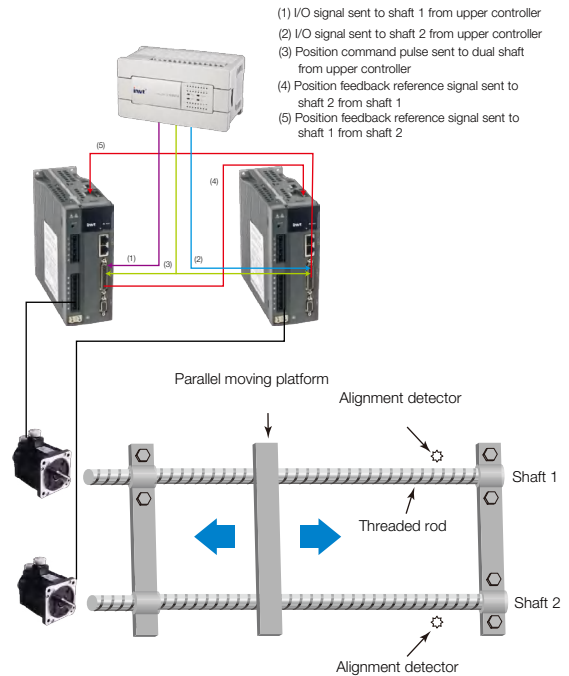
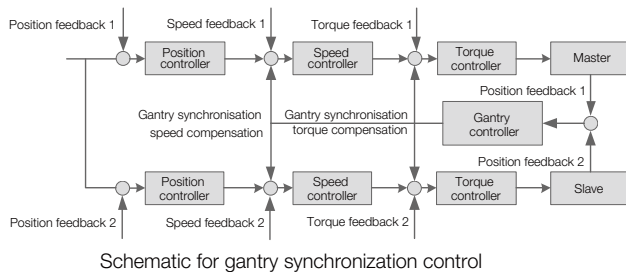

■ Disturbance control

Equipped with the disturbance control function to compensate for the control performance impact caused by load disturbance and parameter changes, enhancing system robustness and greatly improving command following performance.

■ Friction torque compensation

Equipped with the friction torque compensation function to reduce the impact caused by static friction during motor commutation and improve command following performance at low speed running.

■ Simple gain adjusting and switching

The speed and position loop gains and filter time constant can be automatically adjusted by setting rigidity levels, effectively reducing commissioning complicity.

Two groups of gain can be set, and the gains can be switched through I/O input, communication, or internal variables, fulfilling flexible process demands.

■ Speed observer

Using a speed observer to reduce the noise signal impact and improve command following performance.

User-friendly operation software

- Convenient and friendly user interface
- Enriched functions, easy to use
- Built-in instruction manual, practical for commissioning

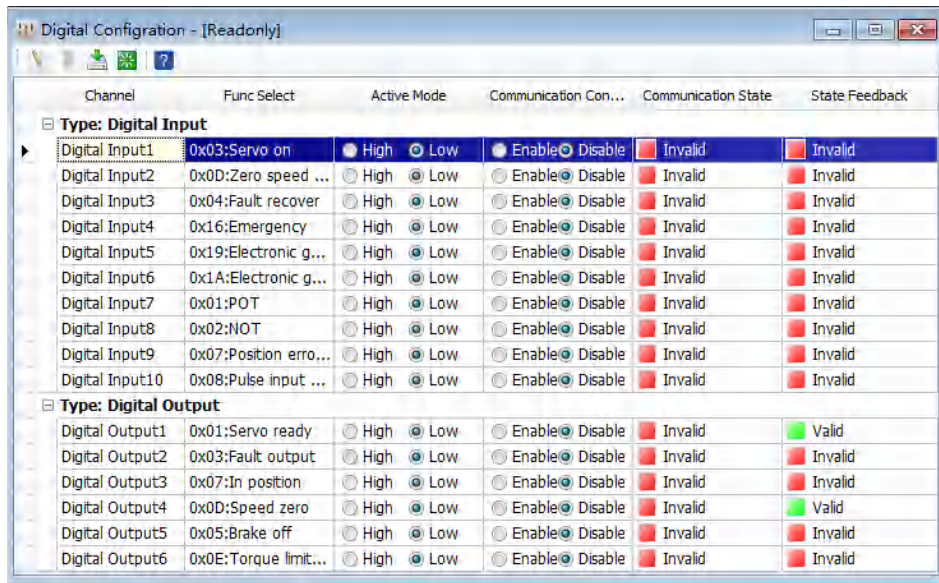

Digital I/O can directly select effective terminal logic and function distribution

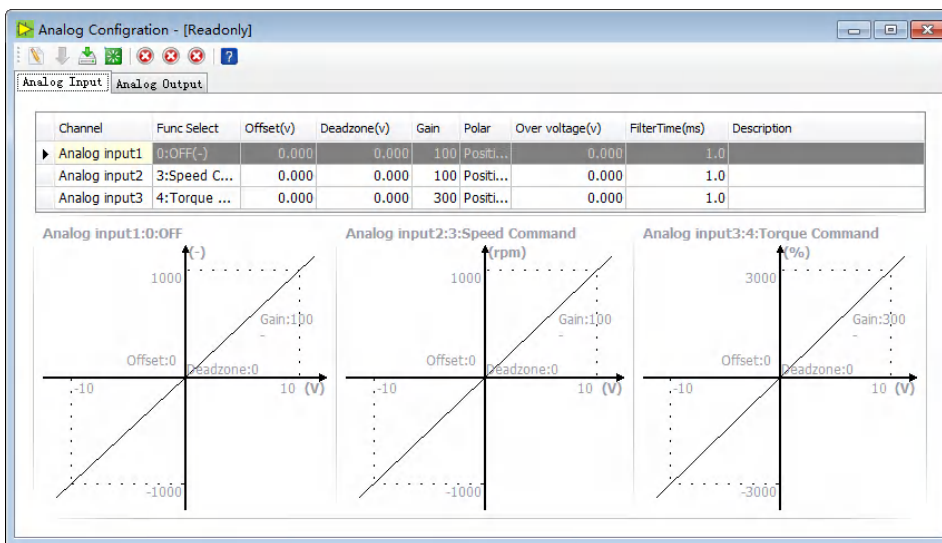

Analog I/O can set parameters such as gain, zero offset and deadzone, as shown above

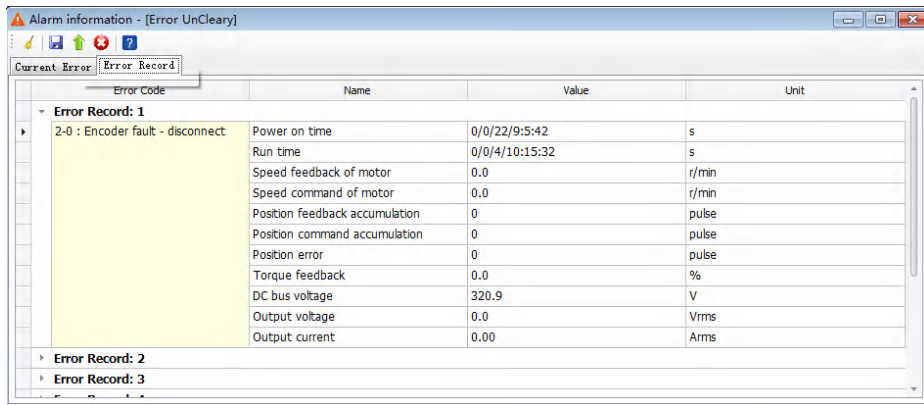

Display fault info. in real time and read fault record info

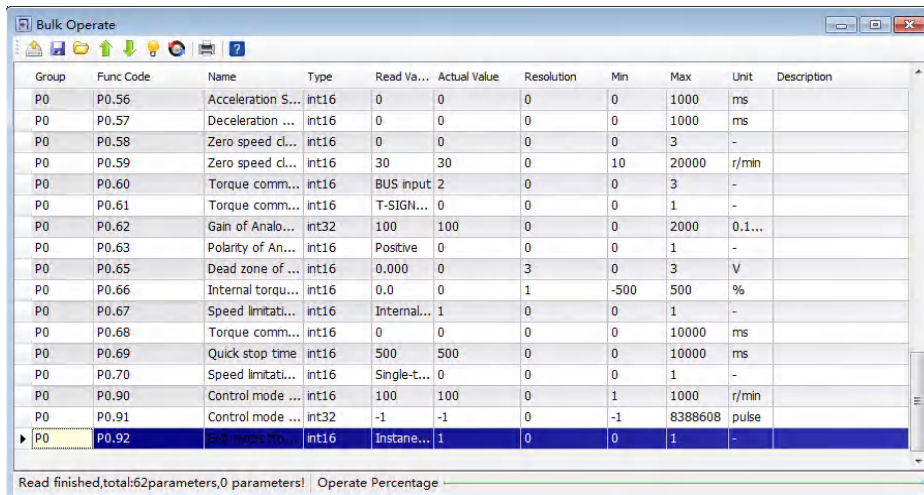

Bulk reading function can store parameters to files for easy parameter copying

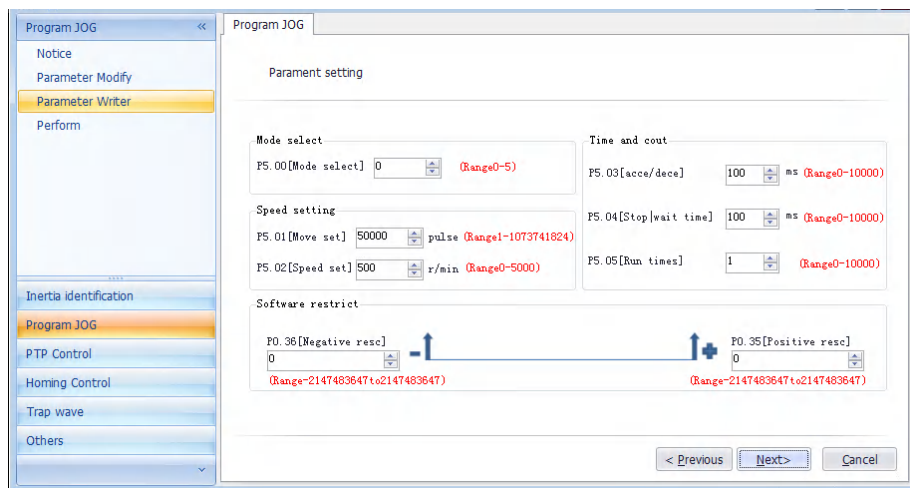

Abundant application control function for convenient pilot run and commissioning

/ Application cases

Mechanical arm/Robot

Function description

- High speed and accuracy: DA200 EtherCAT bus servo uses the 23-bit absolute encoder, achieving the repeated positioning accuracy of $\pm 0.01\text{mm}$ and the response frequency of 2.0kHz.
- High rigidity and flexibility: The high speed and accuracy control on continuous tracks in three dimensions ensures flexibility and accuracy of robot motions, applicable to processes such as high-efficiency dispensing, soldering, cutting, and coating, and compatible with any articulated robot controller.
- Automatic gain adjusting achieves optimum servo performance for each joint.



LED die bonder

Function description

- DA200 supports linear motors, no need for intermediate drive, featuring stronger torque output, quicker dynamic response, and greater ACC, making full use of advanced mechanical performance.
- Improving the die bonder production efficiency through the quick high-accuracy positioning and repeated positioning with the accuracy improved through linear position detection closed-loop feedback control.
- Achieving comprehensive vibration control and excellent disturbance control: fully-closed loop vibration control, low frequency vibration control, disturbance control friction torque compensation, and manual/automatic notch filter.
- Die bonding cycle reduced to 100ms.



Lithium cell winding

Function description

- DA200 EtherCAT bus, with high speed and real time features, supports a maximum of 64 axes, meeting control requirements on winding and soldering machines, and improving assembly efficiency.
- Integrated unwinding and rectification program and excellent algorithms, achieving quick winding, high accuracy cutting, with less tension fluctuation, stable constant linear speed control improving action response.
- Built-in electric cam, easily achieving variable/constant speed winding and quick type change through one key without setting any winding needle dimension parameter.
- Nearby installation for remote I/O, reducing wiring and maintenance costs.
- Winding curves achieved completely through autotuning, without the need to set any winding needle parameters.

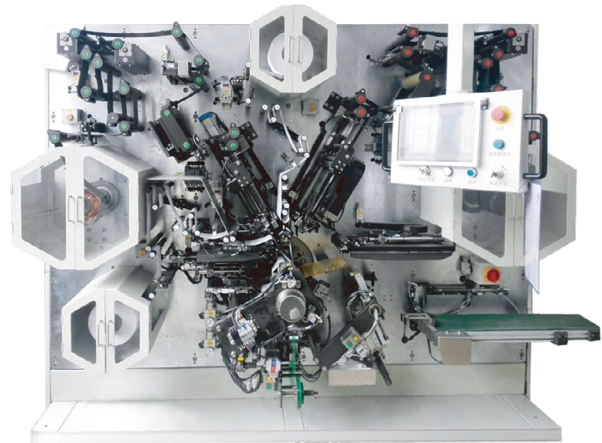

LED sorting machine

Function description

- Utilizing DA200 featuring high speed and excellent response can increase motor frequency width and improve the gains with quick dynamic response and short tuning time, optimizing overall running.
- Using the customized large torque motor with advanced algorithms can achieve high accuracy positioning control and low-speed stable running with high rigidity without microvibrations.
- The max. speed has reached 72K/h, highest level in the industry.
- Rotary table with large inertia, load rate slowed, motor temperature lowered, and noise reduced.
- Working efficiency improved by 80% and yield rate improved greatly.

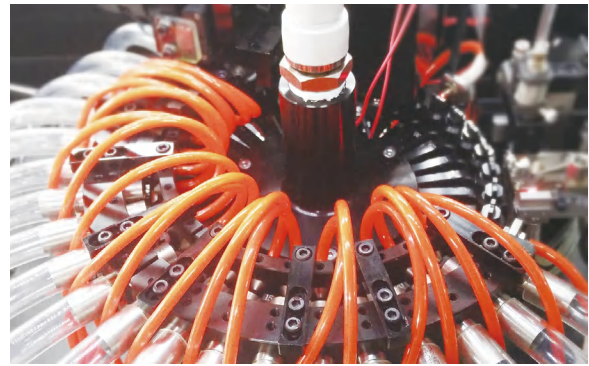

Application cases

Fully auto SMT machine

Function description

- For excellent vibration control, DA200 can fully eliminate resonance and control vibration with quick response, ensuring the machine runs stably.
- Outstanding gantry dual-drive control algorithms ensure running accuracy.
- Excellent online position change function achieves real time change of target positions.
- The high speed and accuracy features help improve SMT production efficiency.



Glass engraving and milling machine

Function description

- Using DA200 to compensate for disturbance, friction, and reverse gap enables the machine to achieve cutting without marks and smooth lines and arcs.
- Excellent disturbance control compensates for load disturbance control and performance impact caused by parameter changes, improving system robustness and command following performance.
- Import of CADs for any graphs and auto optimization of glass cutting traces.
- 4MHz command pulse input.
- Intelligent gain adjusting and switching, implemented through one key.
- Built-in drive protection, featuring excellent environment adaptability and highly waterproof.



Servo drive models

SV-DA200-0R4-2-E 0-XXXX

①

| Symbol | Product category |
|--------|----------------------|
| SV | Servo system product |

①

②

| Symbol | Product category |
|--------|------------------|
| DA200 | Servo drive |

②

| Symbol | Rated power |
|--------|-------------|
| 0R1 | 100W |
| 0R2 | 200W |
| 0R4 | 400W |
| 0R7 | 750W |
| 1R0 | 1.0kW |
| 1R5 | 1.5kW |
| 2R0 | 2.0kW |
| 3R0 | 3.0kW |
| 4R4 | 4.4kW |
| 5R5 | 5.5kW |
| 7R5 | 7.5kW |
| 011 | 11kW |
| 015 | 15kW |
| 022 | 22kW |
| 037 | 37kW |
| 045 | 45kW |
| 055 | 55kW |

③

④

| Symbol | Rated voltage |
|--------|---------------|
| 2 | 220VAC |
| 4 | 400VAC |

⑤

| Symbol | Drive type |
|--------|--------------------|
| E | Pulse type |
| S | Standard type |
| C | CANopen bus type |
| N | EtherCAT bus type |
| F | PROFINET bus type |
| D | PROFdrive bus type |

⑥

| Symbol | Encoder type |
|--------|--------------------------------------|
| 0 | Photoelectric encoder ⁽¹⁾ |
| 7 | Resolver |

⑦

| Symbol | Lot no. |
|--------|-------------------------------------|
| XXXX | Manufacturer lot no. ⁽²⁾ |
| 00Z0 | Linear motor lot no. |
| 00T0 | Electronic cam lot no. |

Remark:

(1).Photoelectric encoders include 2500-PPR incremental, 17-bit multiturn absolute, and 23-bit multiturn absolute encoders.

(2).Lot no. 00Z0 is for linear motors, and s should be 0 (namely, encoder type should be photoelectric encoder.)

Function by drive type (small power range: 100W–5.5kW)

| Drive type | Symbol | Pulse input | 16-bit analog input | 2 nd encoder | STO | RS485 | CANopen | PROFINET | PROFdrive | EtherCAT | Photoelectric encoder | Resolver |
|------------|--------|-------------|---------------------|-------------------------|-----|-------|---------|----------|-----------|----------|-----------------------|----------|
| Pulse | E0 | √ | x | √ | x | √ | x | x | x | x | √ | x |
| Standard | S0 | √ | √ | √ | √ | √ | x | x | x | x | √ | x |
| | S7 | √ | √ | √ | √ | √ | x | x | x | x | x | √ |
| Bus | C0 | x | x | √ | x | x | √ | x | x | x | √ | x |
| | F0 | x | x | √ | x | √ | x | √ | x | x | √ | x |
| | N0 | x | x | √ | x | x | x | x | x | √ | √ | x |
| | D0 | x | x | √ | x | √ | x | x | √ | x | √ | x |

For N0,F0,D0 drive products, if you need STO function, you can communicate with the sales staff to buy customized models.

Function by drive type (medium power range: 7.5W–55kW)

| Drive type | Symbol | Pulse input | 16-bit analog input | 2 nd encoder | STO | RS485 | CANopen | PROFINET | PROFdrive | EtherCAT | Photoelectric encoder | Resolver |
|------------|--------|-------------|---------------------|-------------------------|-----|-------|---------|----------|-----------|----------|-----------------------|----------|
| Standard | S0 | √ | √ | √ | √ | √ | √ | x | x | x | √ | x |
| | S7 | √ | √ | √ | √ | √ | √ | x | x | x | x | √ |
| Bus | N0 | x | x | √ | √ | x | x | x | x | √ | √ | x |
| | N7 | x | x | √ | √ | x | x | x | x | √ | x | √ |
| | F0 | x | √ | √ | √ | √ | x | √ | x | x | √ | x |
| | F7 | x | √ | √ | √ | √ | x | √ | x | x | x | √ |
| | D0 | x | √ | √ | √ | √ | √ | x | √ | x | √ | x |
| | D7 | x | √ | √ | √ | √ | x | x | √ | x | x | √ |

Servo drive models

Drive models and frame sizes

| Model | Input | | Output | | Frame size |
|----------------|-------------|-------------------|------------|-------------------|------------|
| | Voltage (V) | Rated current (A) | Power (kW) | Rated current (A) | |
| SV-DA200-0R1-2 | 1PH/3PH 220 | 0.9/0.4 | 0.1 | 1.3 | A |
| SV-DA200-0R2-2 | 1PH/3PH 220 | 1.8/0.8 | 0.2 | 1.8 | A |
| SV-DA200-0R4-2 | 1PH/3PH 220 | 3.6/1.5 | 0.4 | 3.3 | A |
| SV-DA200-0R7-2 | 1PH/3PH 220 | 6.8/2.8 | 0.75 | 4.5 | B |
| SV-DA200-1R0-2 | 3PH 220 | 9.1/3.7 | 1.0 | 5 | B |
| SV-DA200-1R5-2 | 3PH 220 | 5.6 | 1.5 | 7.6 | B |
| SV-DA200-2R0-2 | 3PH 220 | 7.5 | 2.0 | 10 | D |
| SV-DA200-3R0-2 | 3PH 400 | 11.2 | 3.0 | 13 | D |
| SV-DA200-4R4-2 | 3PH 400 | 16.5 | 4.4 | 16.5 | D |
| SV-DA200-1R0-4 | 3PH 400 | 2.1 | 1.0 | 3.5 | B |
| SV-DA200-1R5-4 | 3PH 400 | 3.1 | 1.5 | 4.5 | B |
| SV-DA200-2R0-4 | 3PH 400 | 4.1 | 2.0 | 6.5 | C |
| SV-DA200-3R0-4 | 3PH 400 | 6.2 | 3.0 | 8.5 | C |
| SV-DA200-4R4-4 | 3PH 400 | 9.1 | 4.4 | 12 | D |
| SV-DA200-5R5-4 | 3PH 400 | 11.3 | 5.5 | 16 | D |
| SV-DA200-7R5-4 | 3PH 400 | 15.5 | 7.5 | 25 | F |
| SV-DA200-011-4 | 3PH 400 | 22.7 | 11 | 33 | F |
| SV-DA200-015-4 | 3PH 400 | 31 | 15 | 50 | F2 |
| SV-DA200-022-4 | 3PH 400 | 45.4 | 22 | 66 | G |
| SV-DA200-037-4 | 3PH 400 | 76 | 37 | 90 | G |
| SV-DA200-045-4 | 3PH 400 | 93 | 45 | 112 | H |
| SV-DA200-055-4 | 3PH 400 | 113 | 55 | 134 | H |

Brake resistor specifications

| Drive model | Built-in brake resistor spec. | Min. allowed resistance of external brake resistor |
|----------------|-------------------------------|--|
| SV-DA200-0R1-2 | / | 60Ω |
| SV-DA200-0R2-2 | / | 60Ω |
| SV-DA200-0R4-2 | / | 60Ω |
| SV-DA200-0R7-2 | 30Ω60W | 30Ω |
| SV-DA200-1R0-2 | 30Ω60W | 30Ω |
| SV-DA200-1R5-2 | 30Ω60W | 20Ω |
| SV-DA200-2R0-2 | 15Ω120W | 15Ω |
| SV-DA200-3R0-2 | 15Ω120W | 15Ω |
| SV-DA200-4R4-2 | 15Ω120W | 15Ω |
| SV-DA200-1R0-4 | 60Ω60W | 60Ω |
| SV-DA200-1R5-4 | 60Ω60W | 60Ω |
| SV-DA200-2R0-4 | 60Ω60W | 40Ω |
| SV-DA200-3R0-4 | 30Ω60W | 30Ω |
| SV-DA200-4R4-4 | 30Ω120W | 30Ω |
| SV-DA200-5R5-4 | 30Ω120W | 30Ω |
| SV-DA200-7R5-4 | / | 30Ω |
| SV-DA200-011-4 | / | 20Ω |
| SV-DA200-015-4 | / | 15Ω |
| SV-DA200-022-4 | / | 10Ω |
| SV-DA200-037-4 | / | 10Ω |
| SV-DA200-045-4 | / | 5Ω |
| SV-DA200-055-4 | / | 5Ω |

EMI filter model selection

| Drive model | EMI filter model |
|----------------|------------------|
| SV-DA200-0R1-2 | FLT-P04006L-B |
| SV-DA200-0R2-2 | |
| SV-DA200-0R4-2 | |
| SV-DA200-0R7-2 | |
| SV-DA200-1R0-4 | |
| SV-DA200-1R5-4 | |
| SV-DA200-1R0-2 | FLT-P04016L-B |
| SV-DA200-1R5-2 | |
| SV-DA200-2R0-4 | |
| SV-DA200-3R0-4 | |
| SV-DA200-2R0-2 | |
| SV-DA200-3R0-2 | |
| SV-DA200-4R4-4 | FLT-P04032L-B |
| SV-DA200-4R4-2 | |
| SV-DA200-5R5-4 | |
| SV-DA200-7R5-4 | |
| SV-DA200-011-4 | FLT-P04045L-B |
| SV-DA200-015-4 | FLT-P04065L-B |
| SV-DA200-022-4 | FLT-P04100L-B |
| SV-DA200-037-4 | FLT-P04100L-B |
| SV-DA200-045-4 | FLT-P04150L-B |
| SV-DA200-055-4 | FLT-P04150L-B |

Remarks: The EMI filter models in the table are INVT EMI filter models, used at the power input end.

Drive dimensions

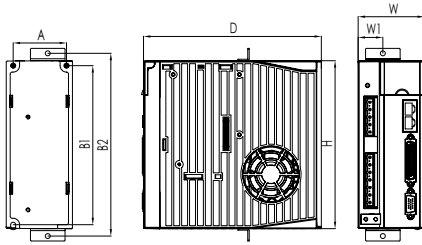

Dimensional drawing for frame sizes A, B, and C

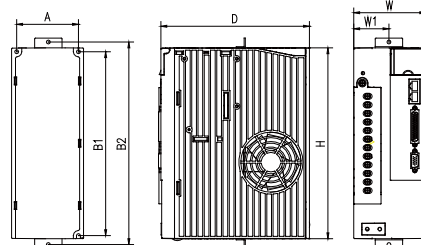

Dimensional drawing for frame size D

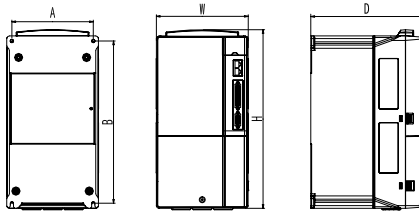

Dimensional drawing for frame sizes F and F2

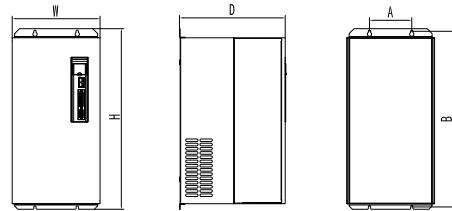

Dimensional drawing for frame size G

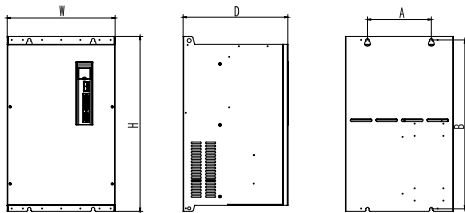

Dimensional drawing for frame size H











| Frame size | Model | Outline dimensions | | | Installation dimensions | | | | Installation size hole (mm) |
|------------|----------------|--------------------|-------|-------|-------------------------|--------|--------|--------|-----------------------------|
| | | H(mm) | W(mm) | D(mm) | A(mm) | B1(mm) | B2(mm) | W1(mm) | |
| A | SV-DA200-0R1-2 | 170 | 45 | 170 | 33 | 162 | 185 | 22.5 | M4(Φ5) |
| | SV-DA200-0R2-2 | | | | | | | | |
| | SV-DA200-0R4-2 | | | | | | | | |
| B | SV-DA200-0R7-2 | 170 | 67 | 180 | 54 | 162 | 185 | 25 | M4(Φ5) |
| | SV-DA200-1R0-2 | | | | | | | | |
| D | SV-DA200-1R5-2 | 245 | 92 | 190 | 79 | 237 | 260 | 45 | M4(Φ5) |
| | SV-DA200-2R0-2 | | | | | | | | |
| | SV-DA200-3R0-2 | | | | | | | | |
| B | SV-DA200-4R4-2 | 170 | 67 | 180 | 54 | 162 | 185 | 25 | M4(Φ5) |
| | SV-DA200-1R0-4 | | | | | | | | |
| C | SV-DA200-1R5-4 | 170 | 84 | 180 | 71 | 162 | 185 | 42 | M4(Φ5) |
| | SV-DA200-2R0-4 | | | | | | | | |
| D | SV-DA200-3R0-4 | 245 | 92 | 190 | 79 | 237 | 260 | 45 | M4(Φ5) |
| | SV-DA200-4R4-4 | | | | | | | | |
| F | SV-DA200-5R5-4 | 342 | 230 | 208 | 210 | 311 | / | / | M5(Φ6) |
| | SV-DA200-7R5-4 | | | | | | | | |
| F2 | SV-DA200-011-4 | 407 | 255 | 238 | 237 | 384 | / | / | M6(Φ7) |
| G | SV-DA200-015-4 | 555 | 270 | 325 | 130 | 540 | / | / | M6(Φ7) |
| | SV-DA200-022-4 | | | | | | | | |
| H | SV-DA200-037-4 | 554 | 338 | 328 | 200 | 535 | / | / | M8(Φ10) |
| | SV-DA200-045-4 | | | | | | | | |
| | SV-DA200-055-4 | | | | | | | | |

Servo drive technical parameters

| DA200 series servo drive (100W–55kW) | | | | |
|--------------------------------------|---|---|---|--|
| Specification | | Description | | |
| Power | 220V system input voltage | 1P/3P AC 220V(-15%)~240V(+10%) 47Hz~63 Hz | | |
| | 400V system input voltage | 3P AC 380V(-15%)~440V(+10%) 47Hz~63Hz | | |
| Port | Control signal | Input | 10 inputs for standard type, pulse type and CANopen bus type; 7 inputs for EtherCAT bus type; 7 inputs for PROFINET bus type(functions can be configured via relevant parameters) | |
| | | Output | 6 outputs for standard type, pulse type and CANopen bus type; 4 outputs for EtherCAT bus type; 4 outputs for PROFINET bus type(functions can be configured via relevant parameters) | |
| | Analog | Input | 3 inputs for standard type (one 16bit, two 12bit analog inputs) 2 inputs for non-standard type (two 12bit analog inputs) | |
| | | Output | 2 outputs (analog monitoring output) | |
| | Pulse signal | Input | 1 input (mode: differential input or open collector) | |
| | | Output | 1 output (mode: differential output (A+, A-, B+, B-, Z+, Z-) or open collector output (A; B; Z)) | |
| | 2 nd encoder | Input | Incremental encoder interface (2nd encoder or grating ruler) | |
| | Communication | USB | 1:1 communication upper PC software (standard) | |
| | | RS485 | 1:n communication (standard) | |
| | | CANopen | 1:n communication (optional) | |
| | | PROFINET | 1:n communication (optional) | |
| | | PROFIdrive | 1:n communication (optional) | |
| | Safety terminal | EtherCAT | 1:n communication (optional) | |
| | | STO | Safe Torque Off (comply with latest Euro safety standard) (optional) | |
| | Control mode | | | 1. Position control; 2. Speed control; 3. Torque control; 4. Position/speed mode switching; 5. Speed/torque mode switching; 6. Position/torque mode switching; 7. Fully-closed loop control; 8. CANopen mode; 9. EtherCAT mode |
| Function | Position control | Control input | 1. Residual pulse clearing; 2. Command pulse input disabled; 3. Electronic gear ratio switching; 4. Vibration control switching | |
| | | Control output | Position complete output | |
| | | Pulse input | Max. pulse input frequency | Photoelectric coupling: differential input 4Mpps, open collector input 200kpps |
| | | | Pulse input mode | 1. Pulse+direction; 2. CW+CCW; 3. Quadrature encoding |
| | | | Electronic gear | 1/10000~1000 |
| | | Filter | 1. Command smooth filter; 2. FIR filter | |
| | | Analog input | Torque limit | Can perform clockwise/anticlockwise torque limit separately |
| | | Vibration control | Can control 5–200Hz front-end vibration and machine vibration | |
| Pulse output | 1. Can perform any frequency division setting which is below encoder resolution rate; 2. B phase reversing function | | | |

| DA200 series servo drive (100W-55kW) | | | | |
|--------------------------------------|-----------------------------------|--|--|---|
| Specification | | Description | | |
| Function | Speed control | Control input | 1. Internal command speed selection 1; 2. Internal command speed selection 2; 3. Internal command speed selection 3; 4. Zero speed clamp | |
| | | Control output | Speed reaching, etc. Speed reaching, etc. | |
| | | Analog input | Speed command input | Can set to speed command input based on analog voltage DC±10V |
| | | | Speed limit input | Can carry out torque limit clockwise/anticlockwise separately |
| | | Internal speed command | Can switch between internal 8-step speed based on external input control | |
| | | Speed command acc/dec adjustment | Can set acc/dec time separately or set acc/dec of S curve | |
| | | Zero speed clamp | In speed mode, zero speed clamp function can set to work in speed mode or position mode | |
| | | Speed command filter | First-order delay filter of analog input speed command | |
| | Speed command zero drift control | Can carry out zero drift control against peripheral disturbance, precision 0.3mV | | |
| | Torque control | Control input | Zero speed clamp input, etc. | |
| | | Control output | Speed reaching, etc. | |
| | | Analog input | Torque command input | Analog torque command input, can set gain and polarity based on analog voltage, precision 4.88mV |
| | | | Speed limit input | Can carry out analog speed limit |
| | | Speed limit | Speed limit can be set via parameters | |
| | | Torque command filter | First-order delay filter of analog input torque command | |
| | Torque command zero drift control | Can carry out zero drift control against peripheral disturbance, precision is 4.88mV | | |
| | Internal position planning | Plan points | Can carry out 128-point internal position plan setting, support communication control positioning | |
| | | Route setting | 1. Position; 2. Speed; 3. Acc time; 4. Dec time; 5. Stop timer; 6. Various state output; 7. Running mode | |
| | | Homing | 1. LS signal; 2. Z phase signal; 3. LS signal+Z phase signal; 4. Torque limit signal | |
| | Protection | Hardware protection | | Overvoltage, undervoltage, overcurrent, overspeed, overload, overheat, brake resistor overload, encoder fault, etc. |
| | | Software protection | | Storage fault, initialization fault, I/O distribution error, position deviation is too large, etc. |
| Protection and fault record | | 1. Can record up to 10 faults 2. Can record the key parameter value when fault occurred | | |
| Environment | Temperature | Working temp | 0~45°C | |
| | | Storage temp | -20~80°C(Non frozen) | |
| | Working/storage RH | | 90%RH(no condensation) | |
| | IP level | | IP20 | |
| | Elevation | | Below 1000m | |
| | Vibration | | ≤5.88m/s ² , 10-60Hz (Do not work on resonance point) | |

Servo drive configuration table

| 1PH/3PH 220V | | | | | | | |
|--------------|---|------------------------|---|------------------------|---|------------------------|------------------------|
| Servo drive |  | |  | |  | | |
| | SIZE A | | SIZE B | | SIZE D | | |
| | SV-DA200-0R1-2 | SV-DA200-0R2-2 | SV-DA200-0R4-2 | SV-DA200-0R7-2 | SV-DA200-1R5-2 | SV-DA200-2R0-2 | SV-DA200-3R0-2 |
| Servo motor | IMS20B-04L10B30C-2-*** | IMS20B-06M20B30C-2-*** | IMS20B-06M40B30C-2-*** | IMS20B-08M75B30C-2-*** | IMS20B-08M10C30C-2-*** | IMS20B-13H13C15C-2-*** | IMS20B-13H18C15C-2-*** |
| | - | - | - | - | IMS20B-13H85B15C-2-*** | IMS20B-13M20C20C-2-*** | IMS20B-13M30C20C-2-*** |
| | - | - | - | - | IMS20B-13M10C20C-2-*** | - | - |
| | - | - | - | - | IMS20B-13M15C20C-2-*** | - | - |
| 3PH 400V | | | | | | | |
| Servo drive |  | |  | |  | | |
| | SIZE B | | SIZE C | | SIZE D | | |
| | SV-DA200-1R0-4 | SV-DA200-1R5-4 | SV-DA200-2R0-4 | SV-DA200-3R0-4 | SV-DA200-4R4-4 | SV-DA200-5R5-4 | |
| Servo motor | IMS20B-13H85B15C-4-*** | IMS20B-13H13C15C-4-*** | IMS20B-13M20C20C-4-*** | IMS20B-13H18C15C-4-*** | IMS20B-18M44C15C-4-*** | IMS20B-18M55C15C-4-*** | |
| | IMS20B-13M10C20C-4-*** | IMS20B-13M15C20C-4-*** | - | IMS20B-13M30C20C-4-*** | - | - | |
| | - | - | - | IMS20B-18M30C15C-4-*** | - | - | |
| Servo drive |  | |  | |  | | |
| | SIZE F | | SIZE F2 | | SIZE G | | |
| | SV-DA200-7R5-4 | SV-DA200-011-4 | SV-DA200-015-4 | | SV-DA200-022-4 | SV-DA200-037-4 | |
| Servo motor | IMS20B-18M75C15C-4-*** | IMS20A-20M11D18C-4-*** | IMS20A-20M18D18C-4-*** | | IMS20A-20M25D18C-4-*** | IMS20A-26M41D20C-4-*** | |
| | - | MS20A-20M16D20C-4-*** | - | | - | - | |
| Servo drive |  | | | | | | |
| | SIZE H | | | | | | |
| | SV-DA200-045-4 | SV-DA200-055-4 | | | | | |
| Servo motor | IMS20A-26M48D20C-4-*** | IMS20A-26M56D20C-4-*** | | | | | |
| | - | IMS20A-26M64D20C-4-*** | | | | | |

Servo motor models

Naming rules

IMS20B-06 M 20B 30C-2-P9

①
②
③
④
⑤
⑥
⑦
⑧
⑨

| Symbol | Symbol instruction | Product category |
|--------|--------------------|--|
| ① | series | IMS Motor |
| ② | Flange (mm) | 04:40 06:60 08:80 13:130 18:180 20:200 26:263 |
| ③ | Inertia | L: Light inertia M:Medium inertia H:Heavy inertia |
| ④ | Rated power (W) | A: X1 B: X10 C: X100 D: X1000 E: X10000 Eg: 40B means 40*10=400W, 55C means 55*100=5500W |
| ⑤ | Rated speed (rpm) | A: X1 B: X10 C: X100 D: X1000 E: X10000 Eg: 30C means 30*100=3000rpm |
| ⑥ | Rated voltage (V) | 2:220 4:380 |
| ⑦ | Encoder type | N: without P: optical M: magnetic R: resolver 3:17bits single-turn 4:17bits multi-turn 9: 23bits multi-turn |
| ⑧ | Seal&brake | 0: with oil seal and no brake(standard omission) 1: without oil seal and no brake 2: with oil seal and permanent magnet brake 3: without oil seal and permanent magnet brake 4: with oil seal and electromagnet brake 5: without oil seal and electromagnet brake |
| ⑨ | Cooling | N: Nature cooling(Default omission) F: Fan cooling |

Servo motor technical parameters

Specification of IMS20B series motor(Absolute encoder type)

| Flange (mm) | Motor model | Rated power (kW) | Rated torque (Nm) | Max torque Nm | Rated speed (rpm) | Max. speed (rpm) | Voltage (V) | Rated current(A) 220V/(380V) | Initial 10 ⁻⁴ kg·m ² without brake/with brake | Weight (kg) with brak/without brake |
|-------------|---------------------------|------------------|-------------------|---------------|-------------------|------------------|-------------|------------------------------|---|-------------------------------------|
| 40 | IMS20B-04L10B30C-2-*** | 0.1 | 0.32 | 1.12 | 3000 | 6000 | 220 | 0.98 | 0.031/0.034 | 0.36/0.55 |
| 60 | IMS20B-06M20B30C-2-*** | 0.2 | 0.64 | 2.23 | 3000 | 6000 | 220 | 1.3 | 0.34/0.35 | 0.8/1.2 |
| 60 | IMS20B-06M40B30C-2-*** | 0.4 | 1.27 | 4.45 | 3000 | 6000 | 220 | 2.6 | 0.59/0.6 | 1.2/1.6 |
| 80 | IMS20B-08M75B30C-2-*** | 0.75 | 2.38 | 8.36 | 3000 | 6000 | 220 | 4.6 | 1.72/1.77 | 2.2/2.9 |
| 80 | IMS20B-08M10C30C-2-*** | 1 | 3.18 | 11.3 | 3000 | 6000 | 220 | 6.3 | 2.23/2.28 | 2.6/3.3 |
| 130 | IMS20B-13M10C20C-2(4)-*** | 1 | 4.8 | 14.3 | 2000 | 4500 | 220(380) | 5.4/3 | 6.3/7.95 | 4.4/6.0 |
| 130 | IMS20B-13M15C20C-2(4)-*** | 1.5 | 7.2 | 21.5 | 2000 | 4500 | 220(380) | 7.6/4.8 | 9.1/10.8 | 5.6/7.2 |
| 130 | IMS20B-13M20C20C-2(4)-*** | 2 | 9.6 | 28.7 | 2000 | 4500 | 220(380) | 9/5.6 | 12.9/14.6 | 6.9/8.5 |
| 130 | IMS20B-13M30C20C-2(4)-*** | 3 | 14.3 | 43 | 2000 | 3000 | 220(380) | 13/7.7 | 21.7/23.4 | 10.3/11.9 |
| 130 | IMS20B-13H85B15C-2(4)-*** | 0.85 | 5.4 | 13.5 | 1500 | 4500 | 220(380) | 6.2/3.3 | 13.1/14.3 | 5.7/7.3 |
| 130 | IMS20B-13H13C15C-2(4)-*** | 1.3 | 8.3 | 20.7 | 1500 | 4500 | 220(380) | 9.9/5.2 | 17.9/19.1 | 7.2/8.8 |
| 130 | IMS20B-13H18C15C-2(4)-*** | 1.8 | 11.5 | 28.7 | 1500 | 4500 | 220(380) | 12.8/7.7 | 24.3/25.6 | 9/10.6 |
| 180 | IMS20B-18M30C15C-4-*** | 3 | 19.1 | 47.8 | 1500 | 4500 | 380 | 9.7 | 48.6/49.3 | 19.2/21.2 |
| 180 | IMS20B-18M44C15C-4-*** | 4.4 | 28 | 70 | 1500 | 4500 | 380 | 13.5 | 65.2/65.9 | 23.2/25.2 |
| 180 | IMS20B-18M55C15C-4-*** | 5.5 | 35 | 88.8 | 1500 | 4500 | 380 | 16.8 | 84/84.7 | 27.7/29.7 |
| 180 | IMS20B-18M75C15C-4-*** | 7.5 | 47.8 | 119.5 | 1500 | 4500 | 380 | 20.9 | 107.4/108.1 | 32/34 |

1. Voltage difference in Model: -2 means 220V,-4 means 400V

2.-*** can be defined as encoder type&brake type:-M3 means 17bits magnetic encoder ,-M34 means 17bits magnetic encoder&electromagnetic brake;-P9 means 23bits optical multi-turn encoder,-P94 means 23bits optical multi-turn encoder&electromagnetic brake

Specification of IMS20A series motor(Absolute encoder\resolver encoder type)

| Flange (mm) | Motor model | Rated power (kW) | Rated torque (Nm) | Max torque Nm | Rated speed (rpm) | Max. speed (rpm) | Voltage (V) | Rated current(A) 220V/(380V) | Initial 10 ⁻⁴ kg·m ² without brake/with brake | Shaft extension/ Shaft diameter (mm) | Bond width (mm) |
|-------------|------------------------|------------------|-------------------|---------------|-------------------|------------------|-------------|------------------------------|---|--------------------------------------|-----------------|
| 200 | IMS20A-20M11D18C-4-*** | 11 | 59 | 147 | 1800 | 2500 | 380 | 29 | 86.3 | 82/42 | 12 |
| 200 | IMS20A-20M16D20C-4-*** | 16 | 77 | 192 | 2000 | 2500 | 380 | 34 | 98.5 | 82/42 | 12 |
| 200 | IMS20A-20M18D18C-4-*** | 18 | 95 | 237 | 1800 | 2500 | 380 | 34.6 | 144 | 82/42 | 12 |
| 200 | IMS20A-20M25D18C-4-*** | 25 | 133 | 330 | 1800 | 2500 | 380 | 55 | 182 | 82/42 | 12 |
| 263 | IMS20A-26M41D20C-4-*** | 41 | 195 | 485 | 2000 | 2500 | 380 | 84.8 | 370 | 110/48 | 14 |
| 263 | IMS20A-26M48D20C-4-*** | 48 | 230 | 575 | 2000 | 2500 | 380 | 104 | 426 | 110/48 | 14 |
| 263 | IMS20A-26M56D20C-4-*** | 56 | 265 | 660 | 2000 | 2500 | 380 | 115 | 523 | 110/48 | 14 |
| 263 | IMS20A-26M64D20C-4-*** | 64 | 306 | 765 | 2000 | 2500 | 380 | 130 | 606 | 110/48 | 14 |

1.-***can be defined as encoder type,cooling type&brake type:-R7 means resolver;-P94F means 23bits optical multi-turn encoder,electromagnetic brake&Fan cooling

Servo motor installation dimensions

Base-40 motor outline dimensions (unit: mm)

Note: Motor structure dimensions may vary with design modification. If you are sensitive to motor dimensions, contact sales staff before ordering.

| Motor model 2500-PPR/Multiturn absolute/ Resolver | L(mm) | |
|---|------------------|------------------|
| | Without brake | With EM brake |
| IMS20B-04L10B30C-2-*** | 73.4 | 100.1 |

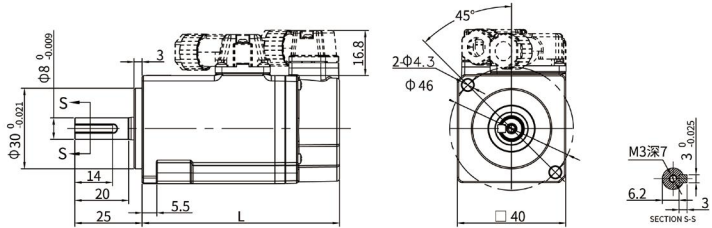

Base-60 motor outline dimensions (unit: mm)

| Motor model 2500-PPR/Multiturn absolute/ Resolver | L(mm) | |
|---|------------------|------------------|
| | Without brake | With EM brake |
| IMS20B-06M20B30C-2-*** | 70.5 | 99.7 |
| IMS20B-06M40B30C-2-*** | 88 | 117.2 |

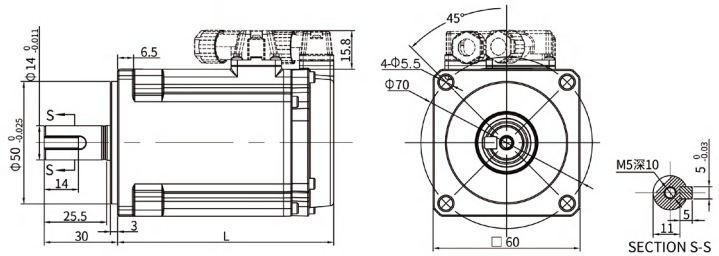

Base-80 motor outline dimensions (unit: mm)

| Motor model 2500-PPR/Multiturn absolute/ Resolver | L(mm) | |
|---|------------------|------------------|
| | Without brake | With EM brake |
| IMS20B-08M75B30C-2-*** | 94.6 | 107.9 |
| IMS20B-08M10C30C-2-*** | 107.9 | 142.1 |

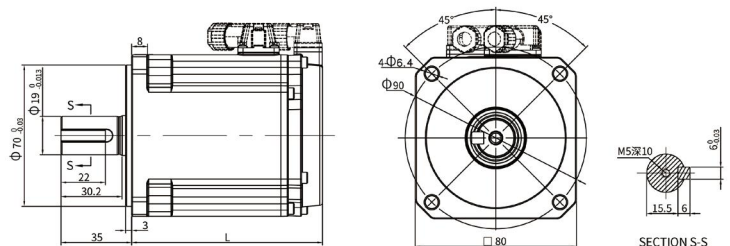

Servo motor installation dimensions

Note: Motor structure dimensions may vary with design modification. If you are sensitive to motor dimensions, contact sales staff before ordering.

Base-130 motor outline dimensions (unit: mm)

| Motor model Magnetic,optical absolute/Resolver | L(mm) | |
|---|---------------|---------------|
| | Without brake | With EM brake |
| IMS20B-13M10C20C-2(4)-*** | 130 | 159 |
| IMS20B-13M15C20C-2(4)-*** | 143 | 172 |
| IMS20B-13M20C20C-2(4)-*** | 160 | 189 |
| IMS20B-13M30C20C-2(4)-*** | 210.5 | 240.2 |
| IMS20B-13H85B15C-2(4)-*** | 138 | 167 |
| IMS20B-13H13C15C-2(4)-*** | 155 | 184 |
| IMS20B-13H18C15C-2(4)-*** | 185 | 215 |

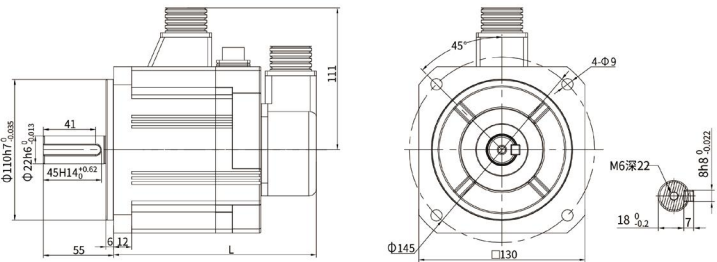

Base-180 motor outline dimensions (unit: mm)

| Motor model Magnetic,optical absolute/Resolver | L(mm) | | S(mm) | |
|---|---------------|---------------|---------------|---------------|
| | Without brake | With EM brake | Without brake | With EM brake |
| IMS20B-18M30C15C-4-*** | 223 | 263 | 35 | 75.3 |
| IMS20B-18M44C15C-4-*** | 248 | 288 | 35 | 75.3 |

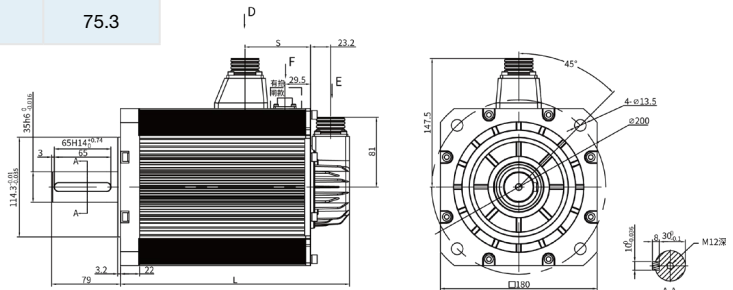

| Motor model Magnetic,optical absolute/Resolver | L(mm) | | S(mm) | |
|---|---------------|---------------|---------------|---------------|
| | Without brake | With EM brake | Without brake | With EM brake |
| IMS20B-18M55C15C-4-*** | 273 | 313 | 35 | 75.3 |
| IMS20B-18M75C15C-4-*** | 308 | 348 | 35 | 75.3 |

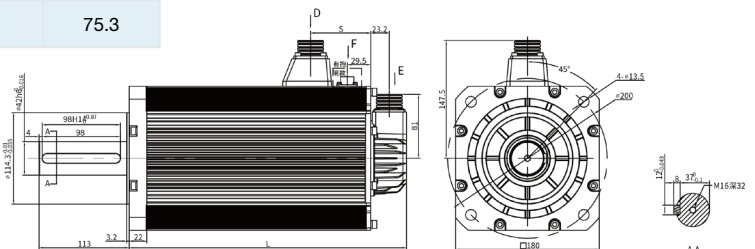

Base-200 motor outline dimensions (unit: mm)

| Motor model Magnetic,optical absolute/Resolver | L(mm) | |
|---|---------------|---------------|
| | Without brake | With EM brake |
| IMS20A-20M11D18C-4-*** | 379 | 515 |
| IMS20A-20M16D20C-4-*** | 414 | 550 |
| IMS20A-20M18D18C-4-*** | 484 | 638 |
| IMS20A-20M25D18C-4-*** | 554 | 692 |

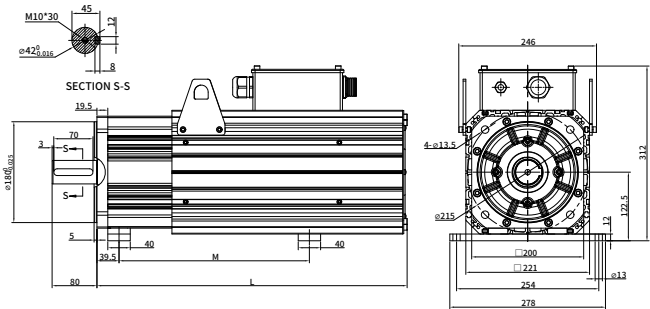

The length of M could be adjusted within the range of L.

Base-263 motor outline dimensions (unit: mm)

| Motor model 2500-PPR/Multiturn absolute/ Resolver | L(mm) | |
|---|---------------|--|
| | Without brake | |
| IMS20A-26M41D20C-4-*** | 537 | |
| IMS20A-26M48D20C-4-*** | 537 | |
| IMS20A-26M56D20C-4-*** | 617 | |
| IMS20A-26M64D20C-4-*** | 657 | |

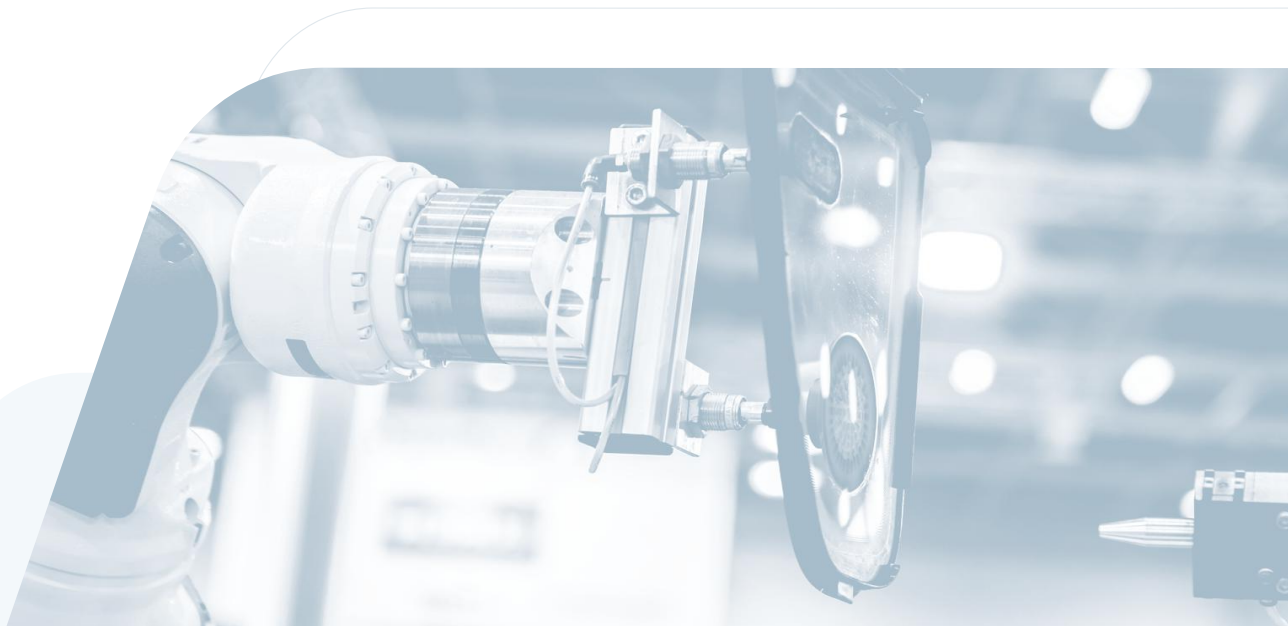
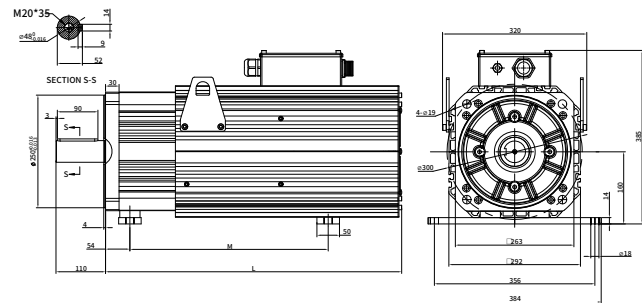

Servo motor torque-speed characteristic

Note: A is a continuous working area; B is a short-time working area.

Base-40 motor

IMS20B-04L10B30C-2-***

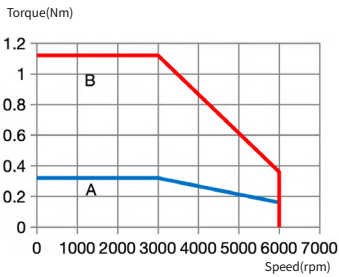

Base-60 motor

IMS20B-06M20B30C-2-***

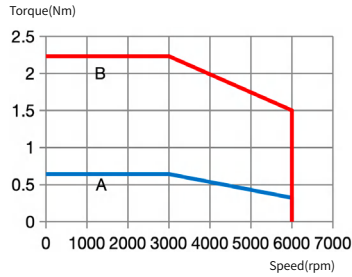

IMS20B-06M40B30C-2-***

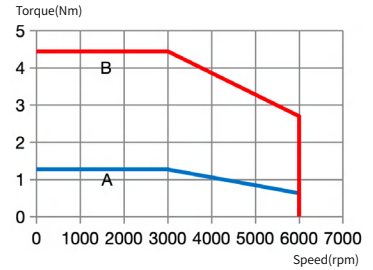

Base-80 motor

IMS20B-08M75B30C-2-***

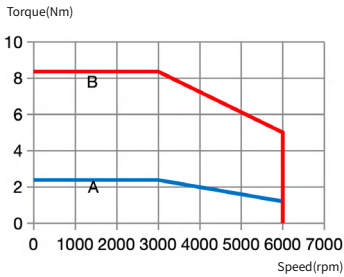

IMS20B-08M10C30C-2-***

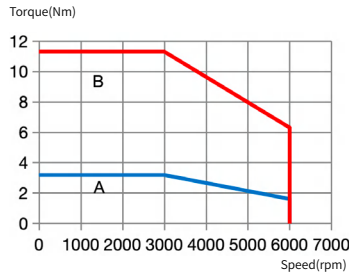

Base-130 motor

IMS20B-13M10C20C-**-***

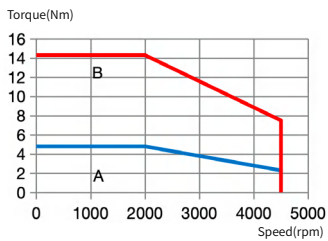

IMS20B-13M15C20C-**-***

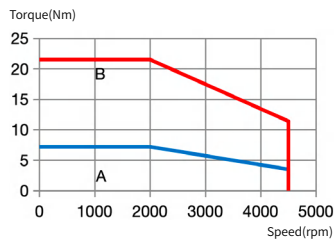

IMS20B-13M20C20C-**-***

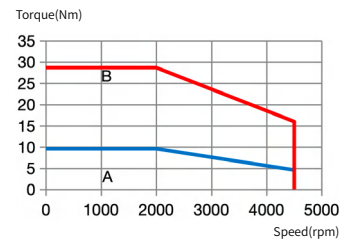

IMS20B-13M30C20C-**-***

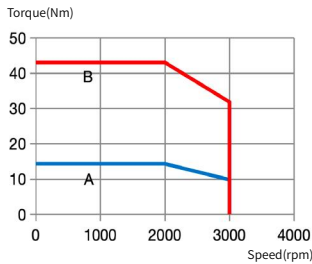

IMS20B-13H85B15C-**-***

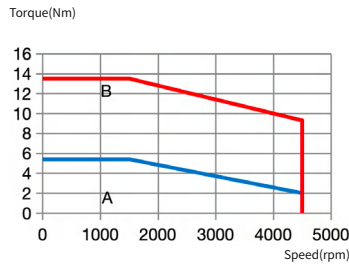

IMS20B-13H13C15C-**-***

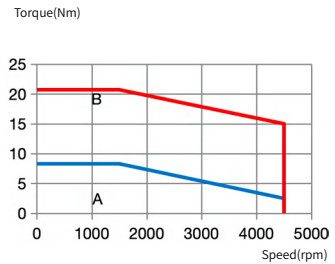

IMS20B-13H18C15C-**-***

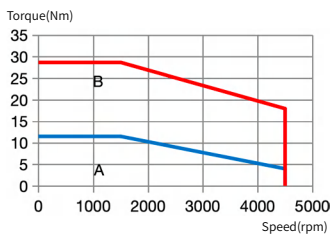

Base-180 motor

IMS20B-18M30C15C-4-***

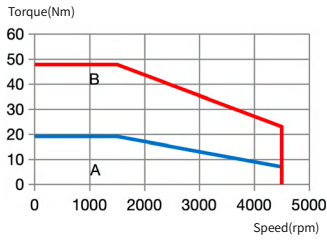

IMS20B-18M44C15C-4-***

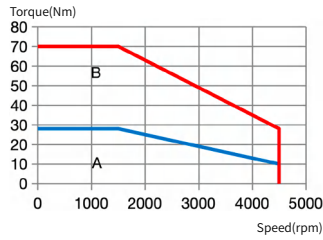

IMS20B-18M55C15C-4-***

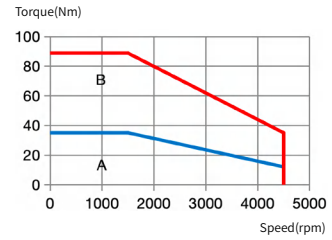

IMS20B-18M75C15C-4-***

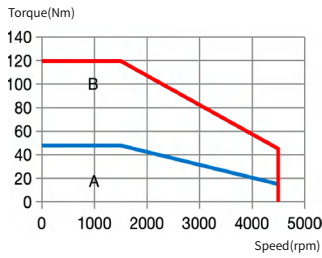

Base-200/263 motor

IMS20A-20M11D18C-4-***

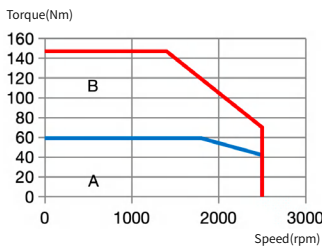

IMS20A-20M16D20C-4-***

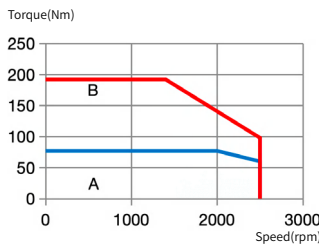

IMS20A-20M18D18C-4-***

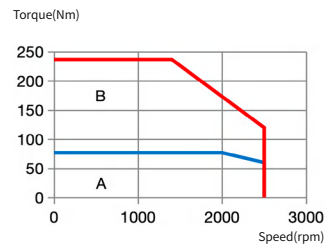

IMS20A-20M25D18C-4-***

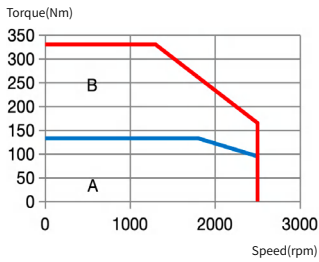

IMS20A-26M41D20C-4-***



IMS20A-26M48D20C-4-***



IMS20A-26M56D20C-4-***

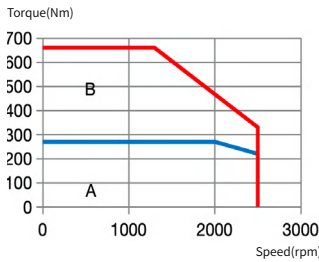

IMS20A-26M64D20C-4-***

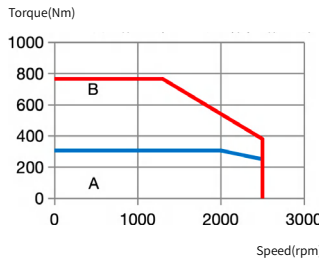

Servo motor power cable models

Power cable

DA ML-050-03-A F 0-00

① ② ③ ④ ⑤ ⑥ ⑦ ⑧

Power cable accessories

DA ML - A F

① ② ⑤ ⑥

①

| Symbol | Supporting series |
|--------|-------------------|
| DA | Manufacturer no. |

②

| Symbol | Cable type |
|--------|-------------|
| ML | Power cable |

③

| Symbol | Cable diameter |
|--------|---------------------|
| 050 | 0.5 mm ² |
| 100 | 1.0 mm ² |
| 250 | 2.5 mm ² |
| 600 | 6.0 mm ² |
| 10R | 10 mm ² |
| 16R | 16 mm ² |
| 25R | 25 mm ² |

④

| Symbol | Cable length |
|--------|--------------|
| 03 | 3m |
| 05 | 5m |
| 10 | 10m |
| ... | Other |

⑤

| Symbol | Motor end plug |
|--------|---------------------------------|
| B | 4PIN regular aviation plug YD28 |
| N | Regular aviation plug YD32 |
| S | Copper tube terminal SC |
| X | Inline plug |

⑥

| Symbol | Drive end plug |
|--------|-------------------------|
| F | Tube-type terminal |
| W | Fork-type terminal |
| S | Copper tube terminal SC |

⑦

| Symbol | Cable material |
|--------|---------------------------------|
| 0 | Regular cable |
| A | Shielded regular cable |
| B | Shielded flexible towline cable |
| F | Flexible towline cable |

⑧

| Symbol | Lot no. |
|--------|------------------|
| 00 | Standard product |
| ... | Other |

Brake cable

BRKL - 03 - A

① ② ③

①

| Symbol | Product series |
|--------|-------------------|
| BRKL | Motor brake cable |

②

| Symbol | Cable length |
|--------|--------------|
| 03 | 3m |
| ... | Other |

③

| Symbol | Motor end plug |
|--------|----------------------------|
| A | 2PIN metal plug |
| B | 3PIN regular aviation plug |
| C | 3PIN metal plug |
| D | 2PIN plastic plug |

Remark: Brake plug in motor package

Servo motor power cable wiring

Power cable for 40/60/80 base (Inline plug+ with brake)

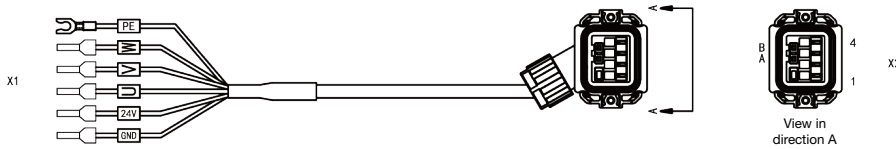

| Wiring relation | | |
|-----------------|--------------------|------|
| Signal | X1 | X2 |
| W | Tube-type terminal | X2.3 |
| V | Tube-type terminal | X2.1 |
| U | Tube-type terminal | X2.2 |
| PE | Fork-type terminal | X2.4 |
| BK+ | Tube-type terminal | X2.A |
| BK- | Tube-type terminal | X2.B |

Power cable for 130 base (YD28 plug)

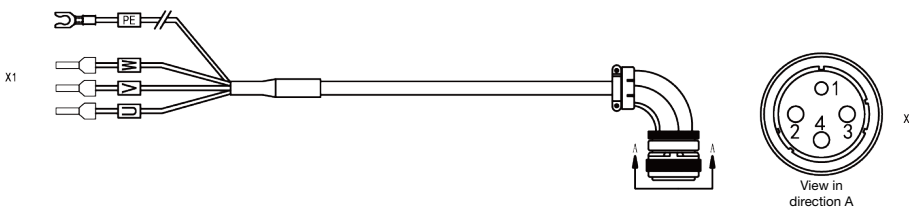

| Wiring relation | | |
|-----------------|-------------------------|------|
| Signal | X1 | X2 |
| W | Tube/Fork-type terminal | X2.4 |
| V | Tube/Fork-type terminal | X2.3 |
| U | Tube/Fork-type terminal | X2.2 |
| PE | Fork-type terminal | X2.1 |

Power cable for 180 base (YD32 plug)

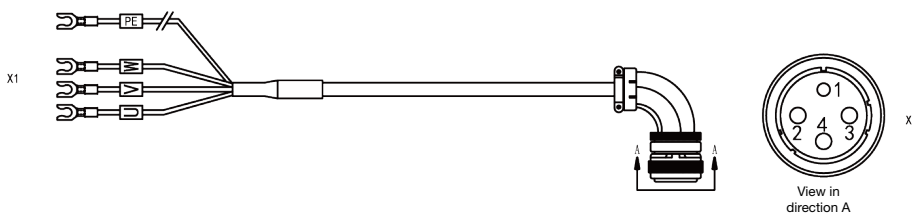

| Wiring relation | | |
|-----------------|-------------------------|------|
| Signal | X1 | X2 |
| W | Tube/Fork-type terminal | X2.4 |
| V | Tube/Fork-type terminal | X2.3 |
| U | Tube/Fork-type terminal | X2.2 |
| PE | Fork-type terminal | X2.1 |

Power cable for base 200/263, 11kW–55kW (380V) motor

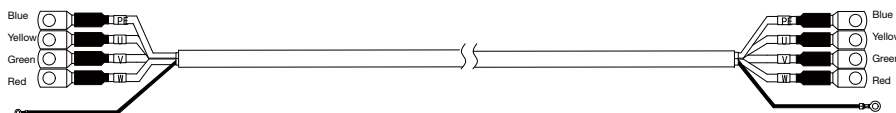

Servo motor encoder cable models

Encoder cable

DB EL - 04 - 03 - B 0 - 04 00

① ② ③ ④ ⑤ ⑥ ⑦ ⑧

Encoder cable accessories

DB EL-A B

① ② ⑨ ⑤

①

| Symbol | Symbol |
|--------|------------------|
| DB | Manufacturer no. |

②

| Symbol | Cable type |
|--------|---------------|
| EL | Encoder cable |

③

| Symbol | Number of cable cores |
|--------|-----------------------|
| 04 | 4 |
| 06 | 6 |

④

| Symbol | Cable length |
|--------|--------------|
| 03 | 3m |
| 05 | 5m |
| 10 | 10m |
| ... | Other |

⑤

| Symbol | Motor end plug |
|--------|----------------------------------|
| B | 15PIN regular aviation plug YD28 |
| D | 9PIN plastic plug |
| X | Inline plug |

⑥

| Symbol | Cable material |
|--------|--|
| 0 | Regular cable |
| D | Regular cable with battery holder |
| F | Flexible towline cable |
| H | Flexible towline cable with battery holder |

⑦

| Symbol | Encoder type |
|--------|--------------|
| 04 | Absolute |
| 07 | Resolver |

⑧

| Symbol | Lot no. |
|--------|---------------|
| 00 | Standard part |
| ... | Other |

⑨

| Symbol | Drive end plug |
|--------|----------------|
| A | 15PIN DB plug |

Servo motor encoder cable wiring

Encoder cable for 40/60/80 base

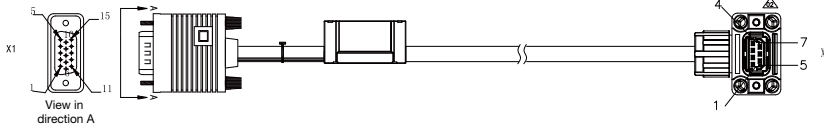

| Wiring relation | | | |
|-----------------|-------------|------|----------------------|
| Signal | X1 | X2 | Core cable structure |
| SD+ | X1.1 | X2.1 | Twisted pair |
| SD- | X1.7 | X2.2 | |
| 5V | X1.5 | X2.5 | Twisted pair |
| GND | X1.12 | X2.6 | Twisted pair |
| VB+ | / | X2.3 | |
| VB- | / | X2.4 | Twisted pair |
| PE | Metal shell | X2.7 | Woven |

Encoder cable for 100/130/180/200/263 base

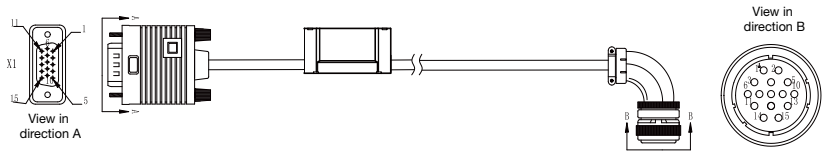

| Wiring relation | | | |
|-----------------|-------------|------|----------------------|
| Signal | X1 | X2 | Core cable structure |
| SD+ | X1.1 | X2.2 | Twisted pair |
| SD- | X1.7 | X2.3 | |
| 5V | X1.5 | X2.4 | Twisted pair |
| GND | X1.12 | X2.5 | Twisted pair |
| VB+ | / | X2.6 | |
| VB- | / | X2.7 | Twisted pair |
| PE | Metal shell | X2.1 | Woven |

Cable for resolver encoder used by flange 200/263 motor

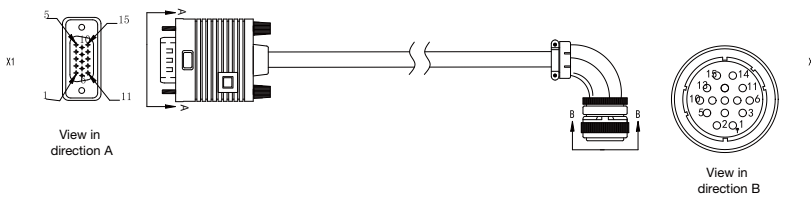

| Wiring relation | | | |
|-----------------|-------------|------|----------------------|
| Signal | X1 | X2 | Core cable structure |
| SIN+ | X1.1 | X2.6 | Twisted pair |
| SIN- | X1.7 | X2.7 | |
| COS+ | X1.2 | X2.5 | Twisted pair |
| COS- | X1.8 | X2.4 | |
| R+ | X1.5 | X2.2 | Twisted pair |
| R- | X1.12 | X2.3 | |
| PE | Metal shell | X2.1 | Woven |

Connection ports

Note: Standard-type examples

Medium power range: 100W–5.5kW

Wiring diagram of main circuit terminal

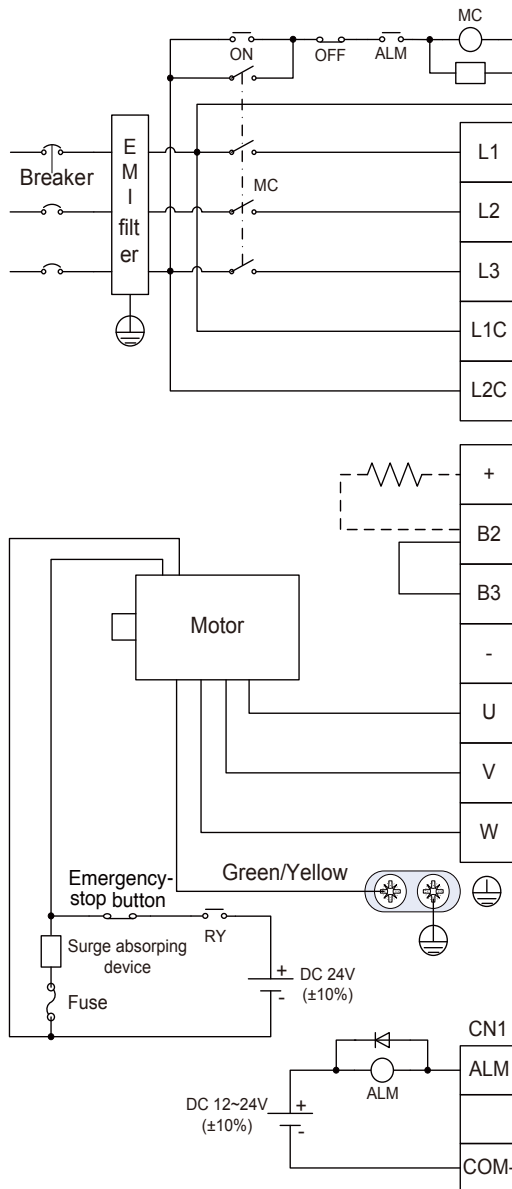

- The user is required to make this emergency stop protection circuit.
- Add surge absorbing devices on both ends of the electromagnetic contactor winding.
- Input voltage range of 400V system: AC 380V(-15%)~440V(+10%)
- It is necessary to connect external regenerative brake resistor between terminal (+) and PB
- Connect output U, V and W to the drive according to the motor cable phase sequence of servo motor, wrong phase sequence will cause drive fault
- Be sure to ground the servo drive to avoid accident of electrical shock.
- The electromagnetic brake uses 24V power supply which should be provided by the user. Moreover, it must be isolated from the DC12-24V power supply which is used by the control signal.
- Pay attention to the connection of the freewheeling diode. Reversed polarity may damage the drive.

CN1

Applicable to the standard (pulse) type

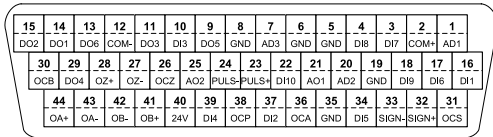

CN1 plug pin layout and signal layout

Applicable to EtherCAT and PROFINET bus communication

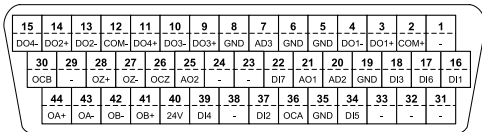

EtherCAT/PROFINET/PROFdrive CN1 plug pin layout and signal layout

CN3

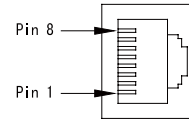

| CN3 terminal function | | | |
|-----------------------|---------|--------------------|--|
| Pin | Name | Function | Remark |
| 1 | GND_CAN | CAN chip power GND | See the table on the left for definition if used as 485/CAN; |
| 2 | GND_485 | 485 chip power GND | |
| 3 | / | / | 485 and CAN use the same interface and each signal has two pins for multiple networking. |
| 4 | RS485+ | RS485 data+ | |
| 5 | RS485- | RS485 data- | |
| 6 | / | / | |
| 7 | CAN_L | CAN data - | |
| 8 | CAN_H | CAN data+ | |

CN2

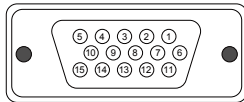

| CN2 terminal function | | | |
|-----------------------|----------|---|---|
| Pin | Name | Function | Remark |
| 1 | V+ / SD+ | Parallel encoder V+ / Serial encoder data+ | Different encoders use different cables |
| 2 | W+ | Signal of parallel encoder W+ | |
| 3 | A+ | Signal of parallel encoder A+ | |
| 4 | A- | Signal of parallel encoder A- | |
| 5 | 5V | Encoder power supply | |
| 6 | U+ | Signal of parallel encoder U+ | |
| 7 | V- / SD- | Parallel encoder V- / Serial encoder data - | |
| 8 | W- | Signal of parallel encoder W- | |
| 9 | B- | Signal of parallel encoder B- | |
| 10 | B+ | Signal of parallel encoder B+ | |
| 11 | U- | Signal of parallel encoder U- | |
| 12 | GND | Power ground | |
| 13 | Z- | Signal of parallel encoder Z- | |
| 14 | Z+ | Signal of parallel encoder Z+ | |
| 15 | / | / | |

CN5

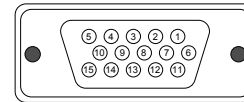

| CN5 terminal function | | | |
|-----------------------|--------|---|---|
| Pin | Name | Function | Remark |
| 1 | HWBB1+ | Safety input 1+ | Connect to grating ruler or 2 nd encoder |
| 2 | HWBB2+ | Safety input 2+ | |
| 3 | EXA+ | Grating ruler (or 2 nd encoder) A+ | |
| 4 | EXA- | Grating ruler (or 2 nd encoder) A- | |
| 5 | EX5V | Power+5V | |
| 6 | EDM+ | Safety monitoring output+ | |
| 7 | HWBB1- | Safety input 1- | |
| 8 | HWBB2- | Safety input 2- | |
| 9 | EXB- | Grating ruler (or 2 nd encoder) B- | |
| 10 | EXB+ | Grating ruler (or 2 nd encoder) B+ | |
| 11 | EDM- | Safety monitoring output- | |
| 12 | EX0V | Power GND, connect to internal GND | |
| 13 | EXZ- | Grating ruler (or 2 nd encoder) Z- | |
| 14 | EXZ+ | Grating ruler (or 2 nd encoder) Z+ | |
| 15 | / | / | |

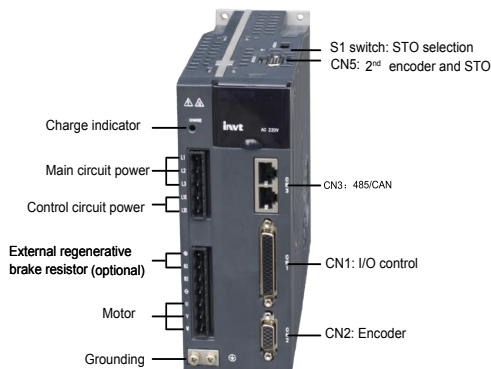

Frame sizes A, B, and C are the same in ports. Frame size B is taken for example.

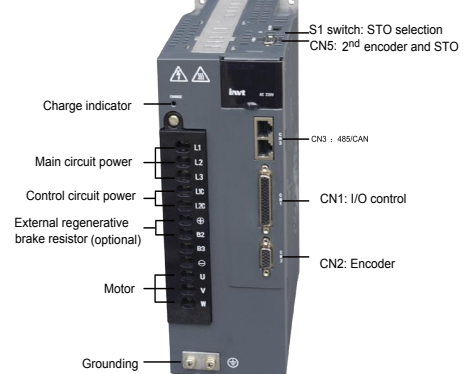

Frame size D

Connection ports

Note: Standard-type examples

Medium power range: 7.5kW-55kW

Wiring diagram of main circuit terminal

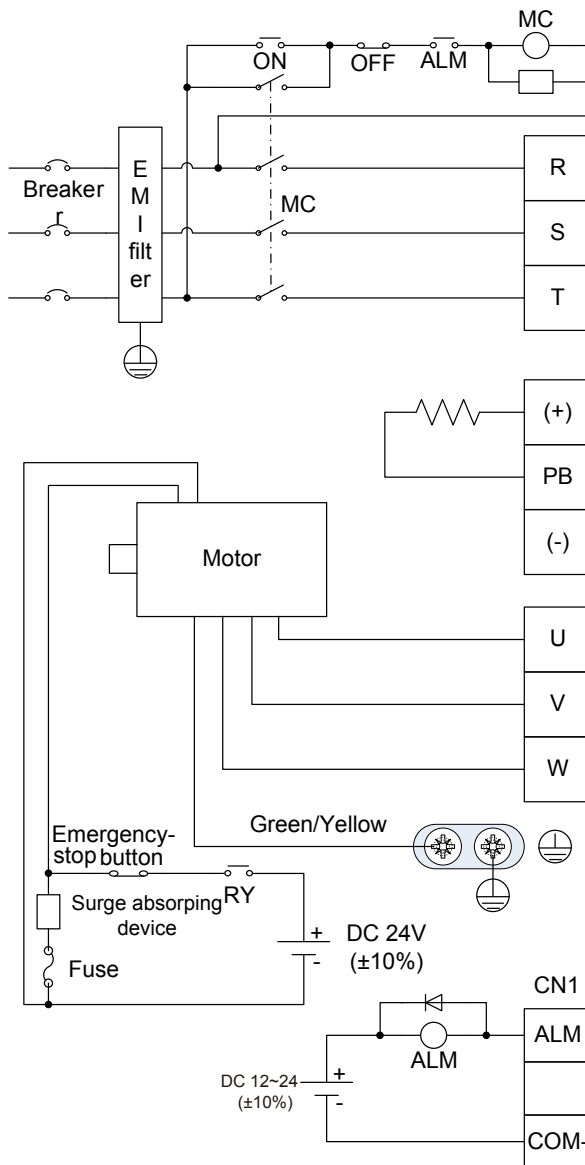

- The user is required to make this emergency stop protection circuit.
- Add surge absorbing devices on both ends of the electromagnetic contactor winding.
- Input voltage range of 400V system: AC 380V(-15%)~440V(+10%)

- It is necessary to connect external regenerative brake resistor between terminal (+) and PB

- Connect output U, V and W to the drive according to the motor cable phase sequence of servo motor, wrong phase sequence will cause drive fault

- Be sure to ground the servo drive to avoid accident of electrical shock.

- The electromagnetic brake uses 24V power supply which should be provided by the user. Moreover, it must be isolated from the DC12-24V power supply which is used by the control signal.

- Pay attention to the connection of the freewheeling diode. Reversed polarity may damage the drive.

CN5

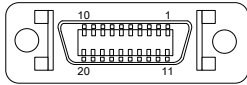

| CN5 terminal function | | | |
|-----------------------|--------|---|---|
| Pin | Name | Function | Remark |
| 1 | EXA+ | Grating ruler (or 2 nd encoder) A+ | Connect to grating ruler or 2 nd encoder |
| 2 | EXA- | Grating ruler (or 2 nd encoder) A- | |
| 3 | EXB+ | Grating ruler (or 2 nd encoder) B+ | |
| 4 | EXB- | Grating ruler (or 2 nd encoder) B- | |
| 5 | EXZ+ | Grating ruler (or 2 nd encoder) Z+ | |
| 6 | EXZ- | Grating ruler (or 2 nd encoder) Z- | |
| 7, 9 | EX5V | Power+5V | |
| 8, 10 | EX0V | Power GND, connect to internal GND | |
| 11 | HWBB1+ | Safety input 1+ | |
| 12 | HWBB1- | Safety input 1- | |
| 13 | EDM+ | Safety monitoring output+ | |
| 14 | EDM- | Safety monitoring output- | |
| 15 | HWBB2+ | Safety input 2+ | |
| 16 | HWBB2- | Safety input 2- | |
| 17 | OC_EXZ | Z phase open collector input | |
| 18 | OC_EXB | B phase open collector input | |
| 19 | OC_EXA | A phase open collector input | |
| 20 | - | Unused | |

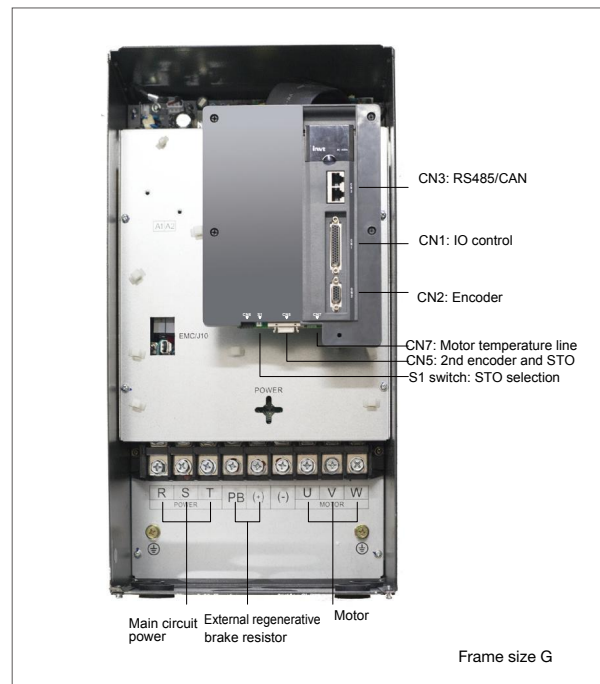
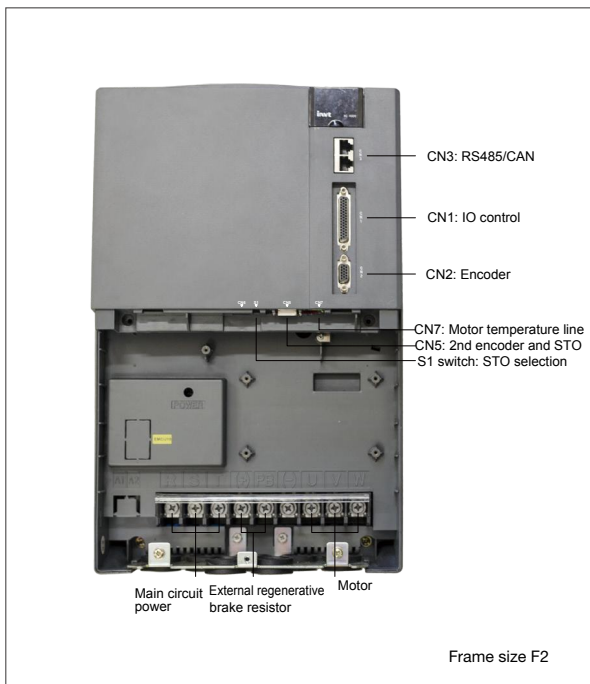
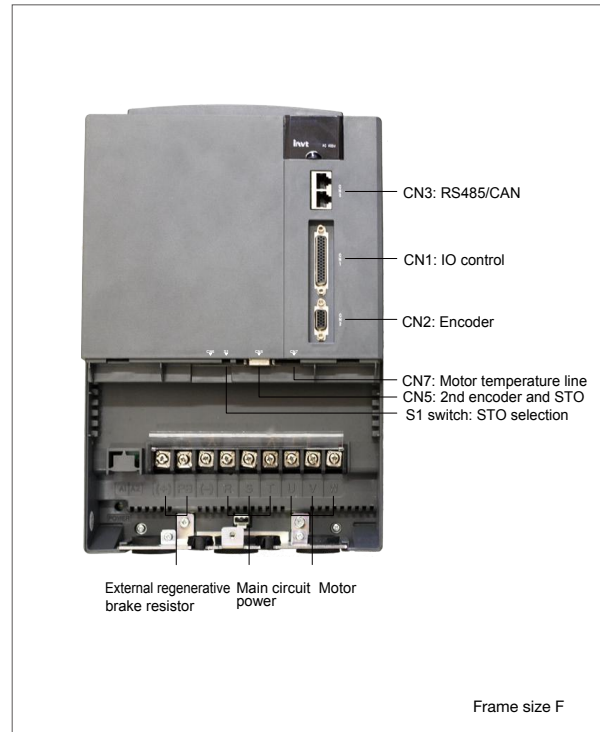

Remarks : The definitions of terminals CN1, CN2 and CN3 are the same for the small power models.

System wiring

Frame size B is taken for example.

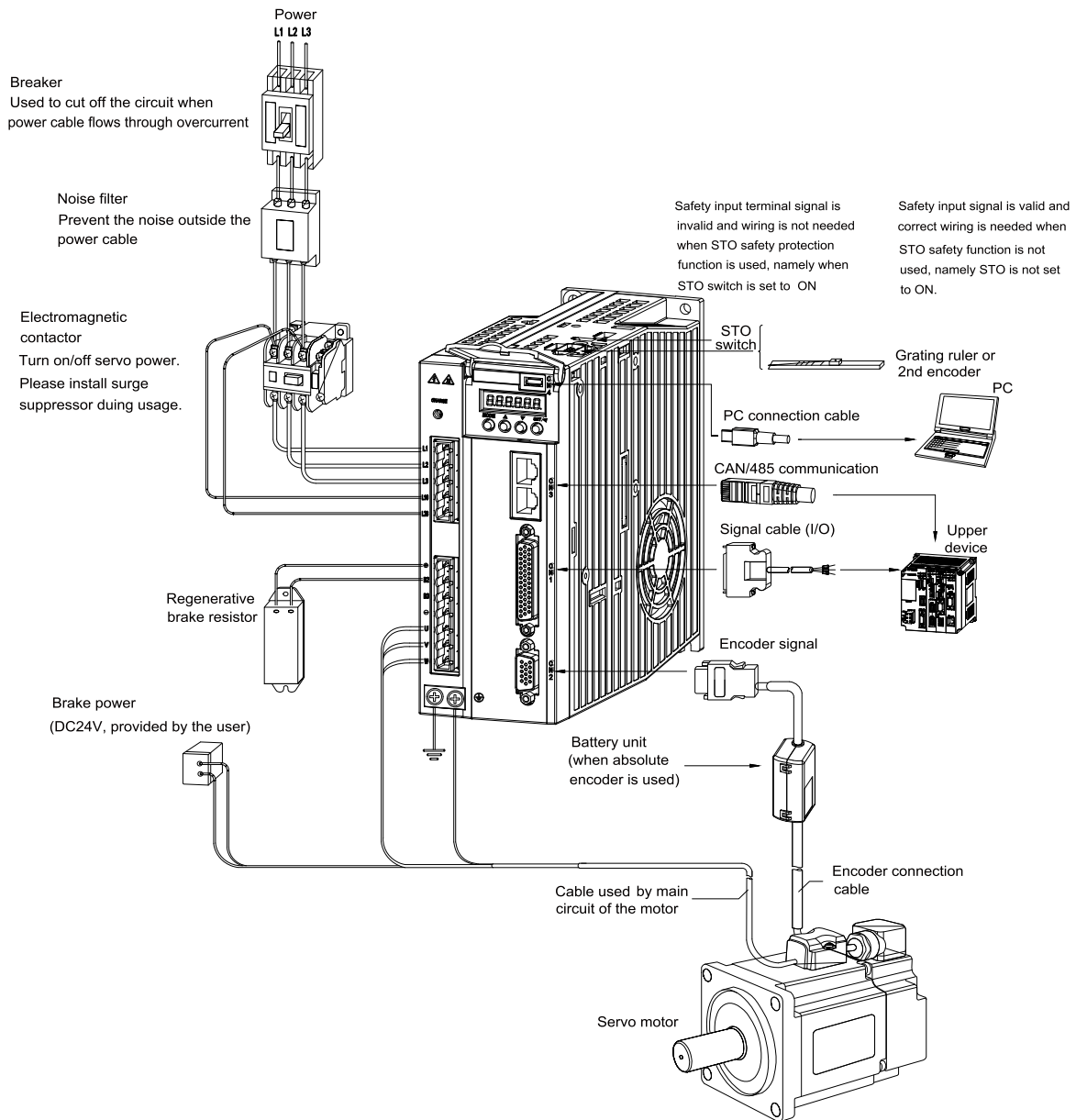

Standard wiring diagram

Wiring diagram of position mode (suitable for pulse input control)

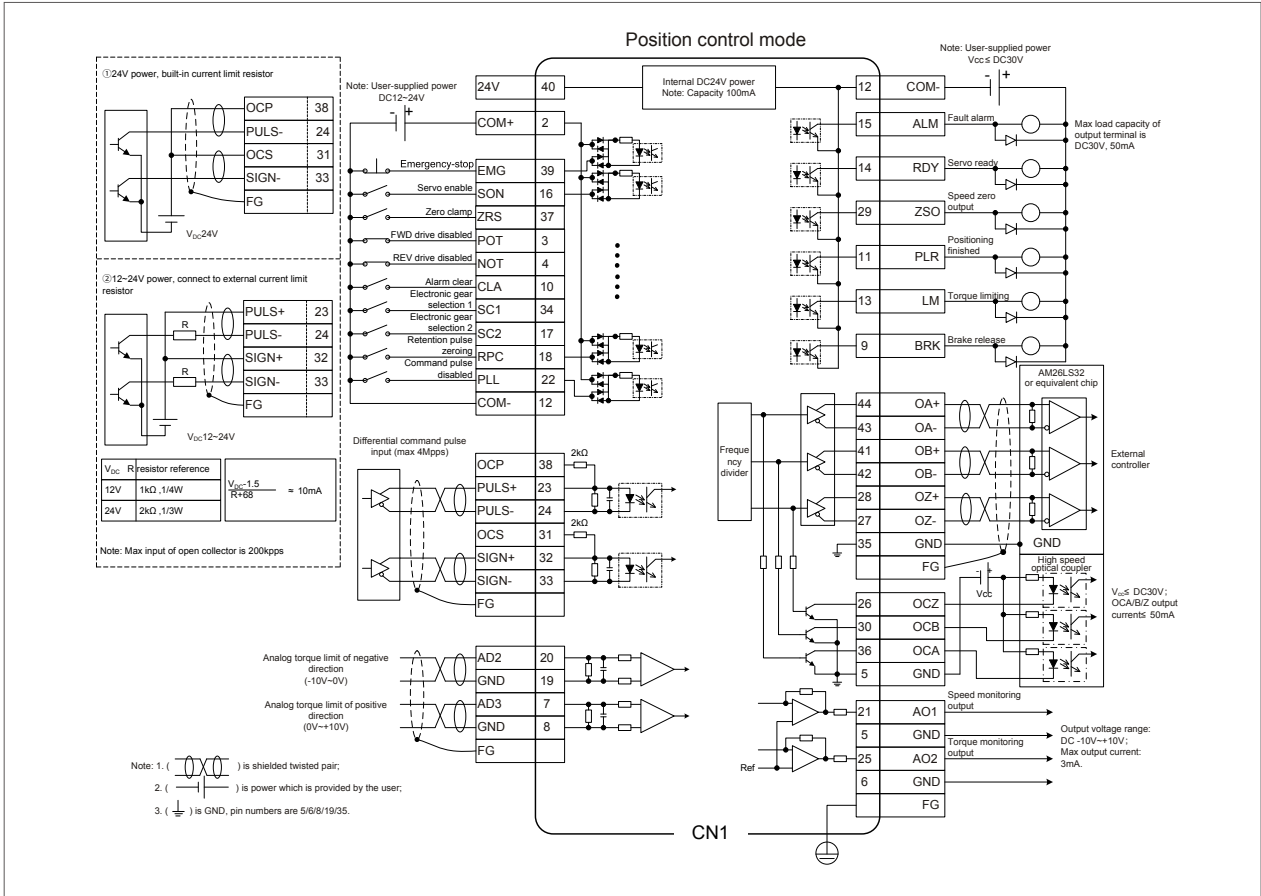

CN1

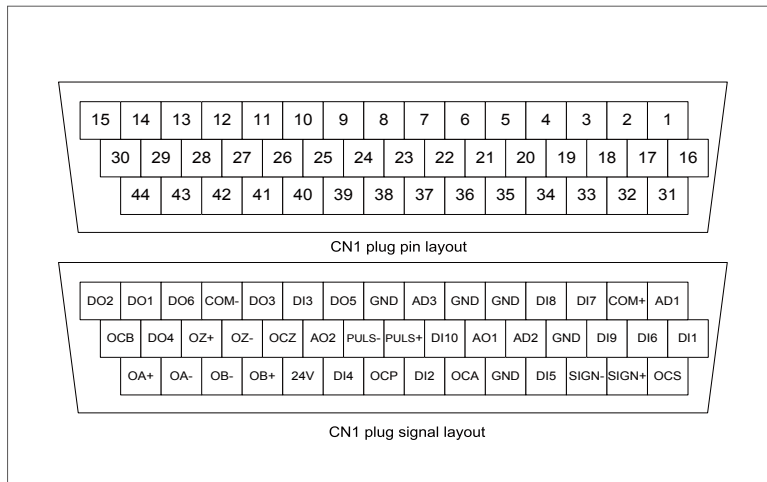

Wiring diagram of torque mode (suitable for analog input control)

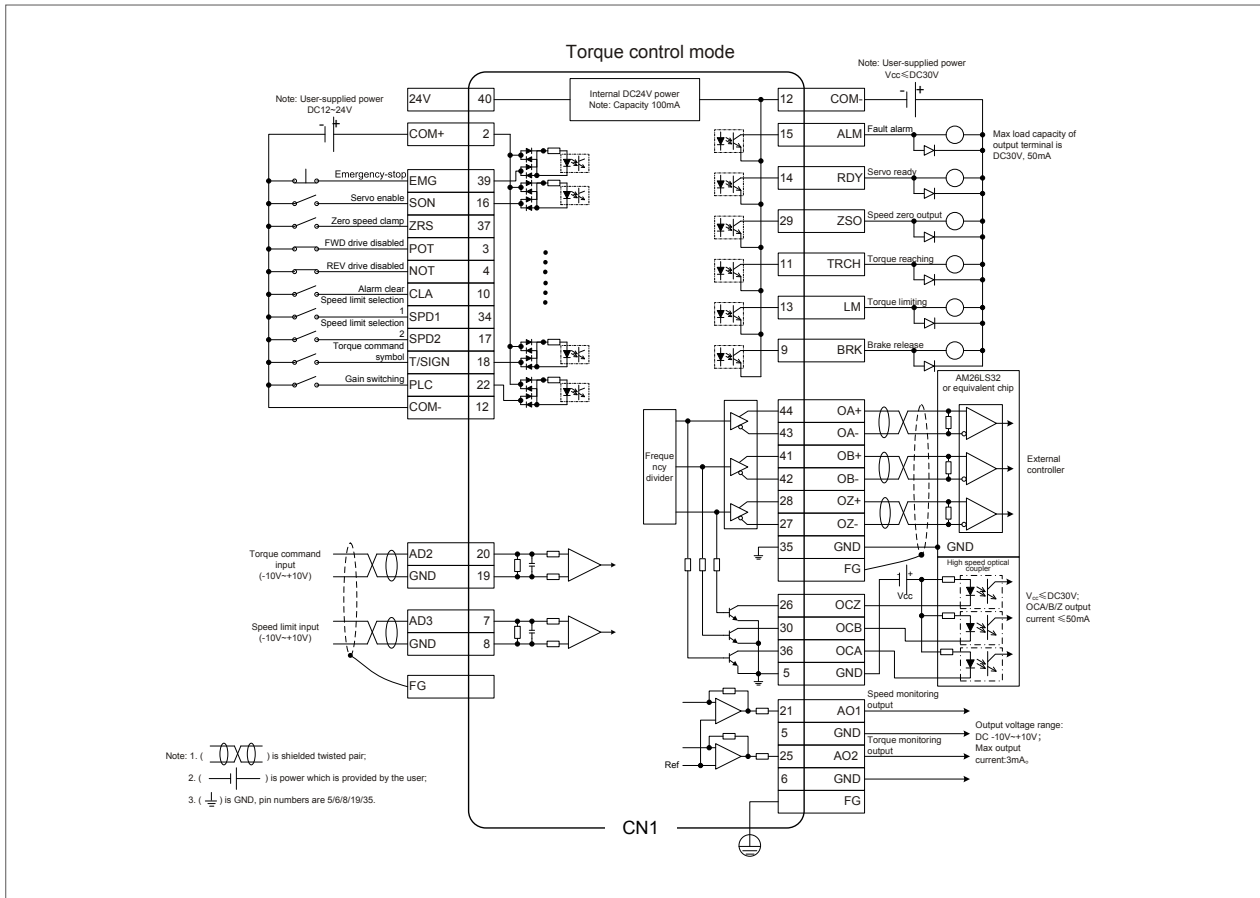

CN1

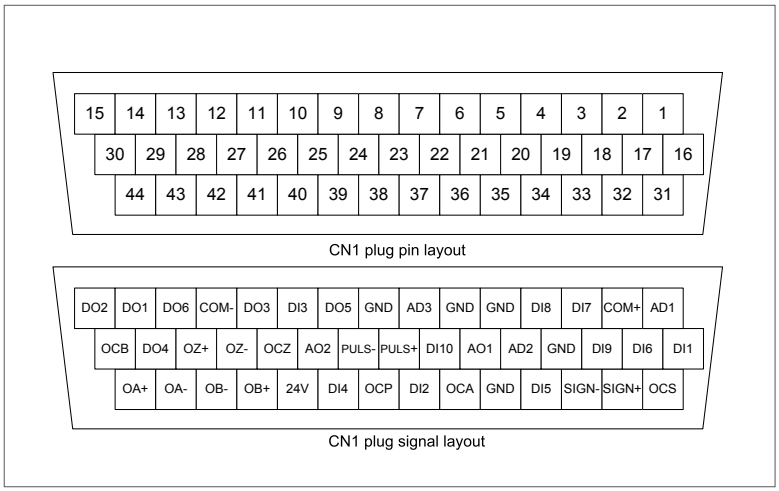

Standard wiring diagram

2nd encoder and STO wiring diagram

Small power range: 100W–5.5kW

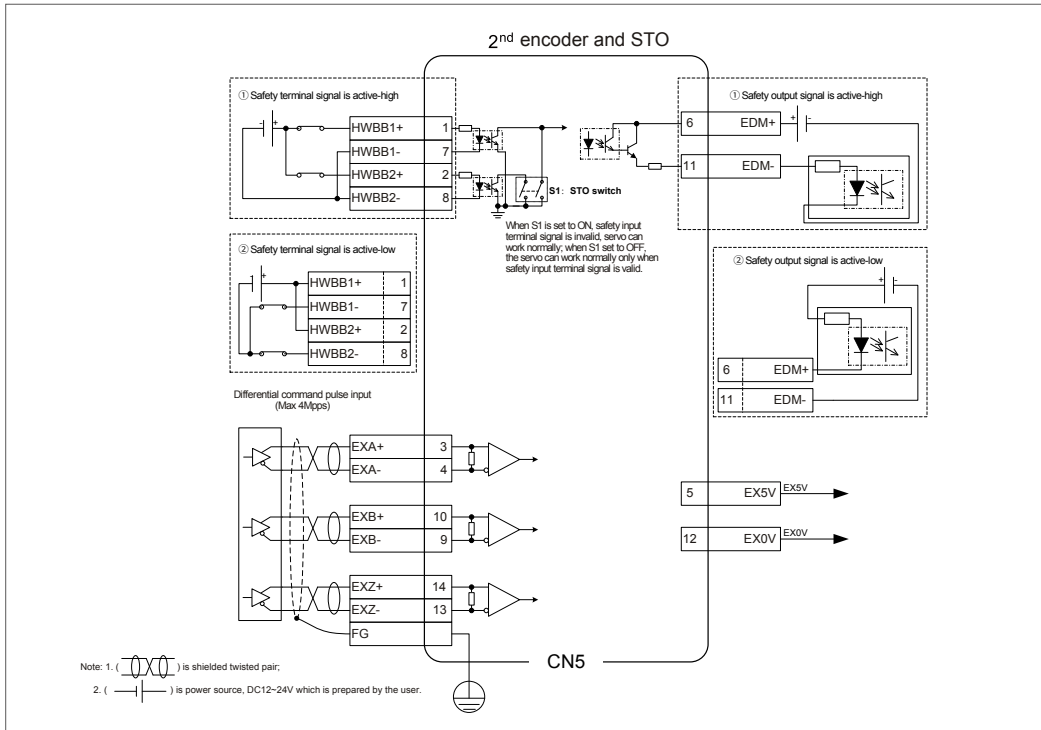

Medium power range: 7.5kW–55kW

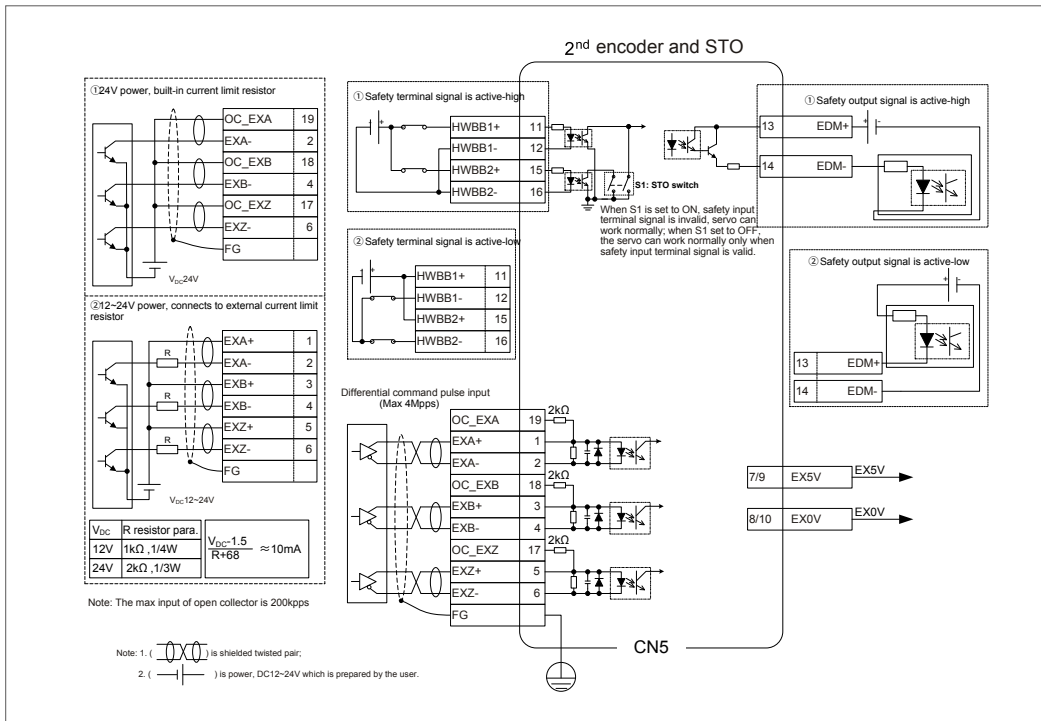

Ordering guide for servo system

| Model | DA200 series | Rated current(A) | Power cable | Encoder cable |
|------------------------|-------------------|------------------|---|---|
| IMS20B-04L10B30C-2-*** | SV-DA200-0R1-2-** | 1.3 | Standard cables: DAML-050-xx-XF0-00 Flexible towline cable: DAML-050-xx-XFF-00 | Without battery box Standard cables: DBEL-04-xx-X0-0400 Flexible towline cable: DBEL-04-xx-XF-0400 |
| IMS20B-06M20B30C-2-*** | SV-DA200-0R2-2-** | 1.8 | | |
| IMS20B-06M40B30C-2-*** | SV-DA200-0R4-2-** | 3.3 | | |
| IMS20B-08M75B30C-2-*** | SV-DA200-0R7-2-** | 4.5 | | |
| IMS20B-08M10C30C-2-*** | SV-DA200-1R5-2-** | 7.6 | With brake Standard cables: DAML-050-xx-XF0-01 With brake Flexible towline cable: DAML-050-xx-XFF-01 | With battery box Standard cables: DBEL-06-xx-XD-0400 Flexible towline cable: DBEL-06-xx-XH-0400 |
| IMS20B-13H85B15C-2-*** | SV-DA200-1R5-2-** | 7.6 | Standard cables: DAML-100-xx-BF0-00 Flexible towline cable: DAML-100-xx-BFF-00 | Without battery box Standard cables: DBEL-06-xx-B0-0400 Flexible towline cable: DBEL-06-xx-BF-0400 With battery box Standard cables: DBEL-06-xx-BD-0400 Flexible towline cable: DBEL-06-xx-BH-0400 Cable for resolver encoder type Standard cables: DBEL-06-xx-B0-0700 Flexible towline cable: DBEL-06-xx-BF-0700 |
| IMS20B-13M10C20C-2-*** | SV-DA200-1R5-2-** | 7.6 | | |
| IMS20B-13M15C20C-2-*** | SV-DA200-1R5-2-** | 7.6 | | |
| IMS20B-13H13C15C-2-*** | SV-DA200-2R0-2-** | 10 | Standard cables: DBML-250-xx-BW0-00 Flexible towline cable: DBML-250-xx-BWF-00 | |
| IMS20B-13M20C20C-2-*** | SV-DA200-2R0-2-** | 10 | | |
| IMS20B-13H18C15C-2-*** | SV-DA200-3R0-2-** | 13 | | |
| IMS20B-13M30C20C-2-*** | SV-DA200-3R0-2-** | 13 | | |
| IMS20B-13H85B15C-4-*** | SV-DA200-1R0-4-** | 3.5 | Standard cables: DAML-100-xx-BF0-00 Flexible towline cable: DAML-100-xx-BFF-00 | |
| IMS20B-13M10C20C-4-*** | SV-DA200-1R0-4-** | 3.5 | | |
| IMS20B-13H13C15C-4-*** | SV-DA200-1R5-4-** | 4.5 | | |
| IMS20B-13M15C20C-4-*** | SV-DA200-1R5-4-** | 4.5 | | |
| IMS20B-13M20C20C-4-*** | SV-DA200-2R0-4-** | 6.5 | | |
| IMS20B-13H18C15C-4-*** | SV-DA200-3R0-4-** | 8.5 | | |
| IMS20B-13M30C20C-4-*** | SV-DA200-3R0-4-** | 8.5 | | |
| IMS20B-18M30C15C-4-*** | SV-DA200-3R0-4-** | 8.5 | | |
| IMS20B-18M44C15C-4-*** | SV-DA200-4R4-4-** | 12 | Standard cables: DBML-250-xx-NW0-00 Flexible towline cable: DBML-250-xx-NWF-00 | |
| IMS20B-18M55C15C-4-*** | SV-DA200-5R5-4-** | 16 | | |
| IMS20B-18M75C15C-4-*** | SV-DA200-7R5-4-** | 25 | Standard cables: DBML-600-xx-NWA-00 Flexible towline cable: DBML-600-xx-NWF-00 | |
| IMS20A-20M11D18C-4-*** | SV-DA200-011-4-** | 33 | Standard cables: DAML-10R-xx-SSA-00 | |
| IMS20A-20M16D20C-4-*** | SV-DA200-011-4-** | 33 | | |
| IMS20A-20M18D18C-4-*** | SV-DA200-015-4-** | 50 | Standard cables: DAML-16R-xx-SSA-00 | |
| IMS20A-20M25D18C-4-*** | SV-DA200-022-4-** | 66 | | |
| IMS20A-26M41D20C-4-*** | SV-DA200-037-4-** | 90 | Standard cables: DAML-25R-xx-SSA-00 | |
| IMS20A-26M48D20C-4-*** | SV-DA200-045-4-** | 112 | | |
| IMS20A-26M56D20C-4-*** | SV-DA200-055-4-** | 134 | | |
| IMS20A-26M64D20C-4-*** | SV-DA200-055-4-** | 134 | | |

Remarks:

1. The cable section xx represents the length, such as 03:3 meters

Other INVT industrial control products



■ PLC

- Complete categories for wide applications
- Abundant extension modules for easy function extension
- Support for various communication protocols, flexible networking
- Compact size for easy maintenance



■ Linear motor drive

- Support for magnetic pole alignment of linear motors without auxiliary signal
- Support for various grating and magnetic rulers
- Stronger torque output and quicker dynamic response, without intermediate drive
- Closed-loop feedback control on linear position detection, with high accuracy positioning in short time and high dynamic rigidity
- Parameter unit consistency in commissioning interface, without conversion
- Short ACC/DEC and high efficiency of drive, without travel limit



■ Motion controller

- Various motion controller cards
- All series motion controller
- Robot control system
- Customized digital control system



■ VFD

- The most comprehensive inverter lines in the industry, covering from low, medium to high voltage VFDs
- Customized products based on customer needs are available



■ DL310 DC Low voltage servo drive

- It is widely used in logistics, textile and other special industries.

/"One-stop" service

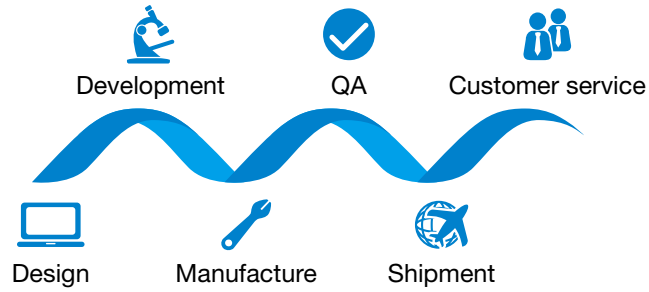

Service network

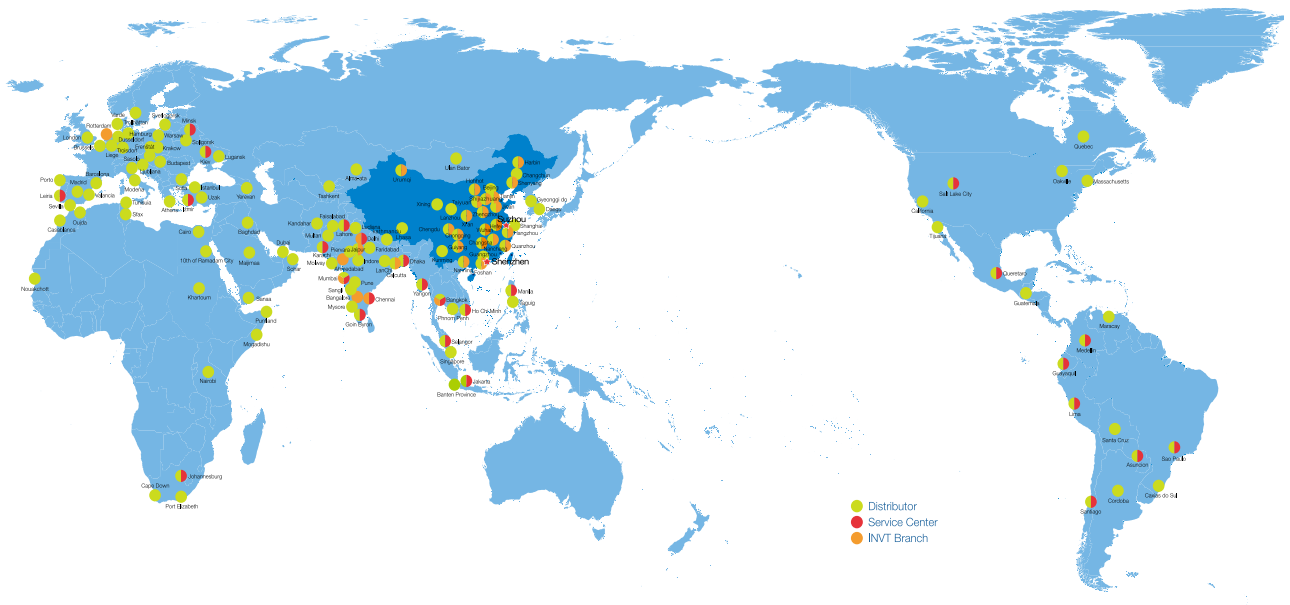

Your trusted industry automation solution provider

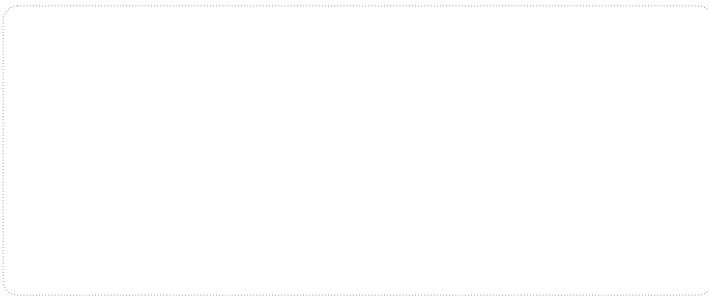

E-mail: overseas@invt.com.cn Website: www.invt.com

SHENZHEN INVT ELECTRIC CO.,LTD. INVT Guangming Technology Building, Songbai Road, Matian, Guangming District, Shenzhen, China

- | | | | | |
|-------------------------------|--|---------------------------------------|----------------------------|-----------------------------------|
| Industrial Automation: | • Frequency AC Drive | • Servo & Motion Control | • Motor & Electric Spindle | • PLC |
| | • HMI | • Intelligent Elevator Control System | • Traction Drive | |
| Electric Power: | • SVG | • Solar Pump Controller | • UPS | • Online Energy Management System |
| | • New Energy Vehicle Electric Control System | | | |

INVT Copyright.
Information may be subject to change without notice during product improving.

66003-00104 202407(V7.0)